

PROFILY ALUPLAST

Aluplast IDEAL 4000 Economic



- 6 komorový profil
- stavebná hĺbka 70 mm
- dvojité dorazové vymeniteľné tesnenie
- kovanie WinkHaus
- oceľová pozinkovaná výstuha
- izolačné dvojsklo plné argónom
- koeficient $U_f = 1,2 \text{ W/m}^2\text{K}$

Aluplast IDEAL 4000 Roundline

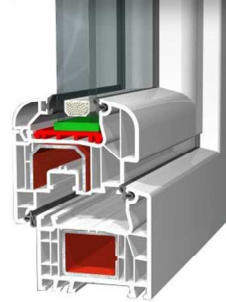

- 6 komorový profil
- stavebná hĺbka 70 mm
- dvojité dorazové vymeniteľné tesnenie
- kovanie WinkHaus
- oceľová pozinkovaná výstuha
- izolačné dvojsklo plné argónom
- koeficient $U_f = 1,2 \text{ W/m}^2\text{K}$

VZORKY FARIEB

ALUPLAST IDEAL 4000

Aluplast

Štandardné farby:

Príplatky za farbu:	vonkajšiu	+ 22 %
	vnútornú	+ 29 %
	obojsmernú	+ 42 %

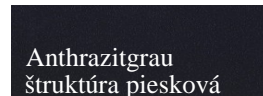

Poznámka: neštandardné farby v profile Aluplast sa individuálne vycenenia podľa počtu kusov

DOPLNKOVÝ TOVAR

ALUPLAST IDEAL 4000 a ALUPLAST IDEAL 5000

<u>Stĺpik v krídle</u>	17,-/ bm	
<u>Príplatok za stredný pánt</u>	8,50,-/ ks (štandardne sú dva)	
<u>Príplatok za balkónovú priečku</u>	10,-/ bm	
<u>Teplý rámik</u>	7,-/ m ²	
<u>Príplatok za zmenu funkcie z O na OS</u>	10,-/ ks	
<u>Plastové výplne:</u>		
<u>biela (24 mm)</u>	50,-/ m ²	
<u>jednostranná farba (24 mm)</u>	100,-/ m ²	
<u>obojsstranná farba (24 mm)</u>	127,-/ m ²	
<u>Bezpečnostné sklo</u>	45,-/ m ²	POZOR: v prípade skla do 0,50 rátať ako za ks 45€/ 1ks
<u>Bezpečnostné sklo P2</u>	60,-/ m ²	
<u>Bezpečnostné sklo P4</u>	65,-/ m ²	
<u>Antisol hnedý</u>	40,-/ m ²	
<u>Reflexné sklo, stopsol</u>	65,-/ m ²	
<u>Mliečne sklo</u>	40,-/ m ²	
<u>Dubová kôra</u>	30,-/ m ²	
<u>Dubová kôra do 0,55</u>	30,-/ ks	
<u>Drôtosklo</u>	85,-/ m ²	
<u>Drôtosklo do 0,55</u>	35,-/ ks	

Poznámka: na doplnkový tovar sa vzťahuje zľava

DOPLNKOVÝ TOVAR

ALUPLAST IDEAL 4000 a ALUPLAST IDEAL 5000







<u>Zmena výšky kľučky</u>	10,-/ 1 kľučka
<u>Trojstupňové polohovateľne sklápanie okna</u>	7,-/ krídlo
<u>Hliníkový prah</u>	36,-/ bm
<u>Kľučka s kľúčom (biela a hnedá)</u>	17,-/ ks
<u>Poistka balkónových dverí</u>	8,-/ ks
<u>Farebné fixy</u>	13,-/ ks
<u>Kľučky Secustic (staré zlato, strieborné)</u>	5,-/ ks
<u>Kľučky Secustic (pri sam. objednaní)</u>	3,-/ ks
<u>Kľučky pri objednávke okien:</u>	1,10,-/ks
<u>Mriežky v skle</u>	
biele 8, 18, 26 mm	5,-/ pole
biele 45 mm	8,50,-/ pole
zlaté 8 mm	5,-/ pole
zlaté 18, 26 mm	10,-/ pole
iná farba 18, 26 mm	9,-/ pole
<u>Izolačné trojsklo 4/12/4/12/4 (k = 0,7)</u>	12,-/ m ²
<u>Izolačné trojsklo 4/12/4/12/4 do O,5 m²</u>	15,-/ ks

Poznámka: na doplnkový tovar sa nevzťahuje zľava

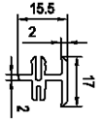
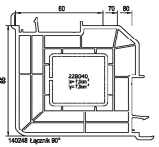
DOPLNKOVÝ TOVAR

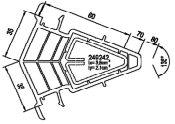
ALUPLAST IDEAL 4000 a ALUPLAST IDEAL 5000

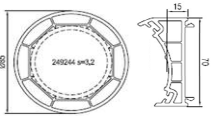
SPOJOVACIE PROFILY

<p><u>Spojovací profil:</u></p>  <p>typ malé H</p>	<p><u>Cena za farbu:</u></p> <p>Biela: 4,-/ bm 1x farba: 7,-/ bm 2x farba: 8,-/ bm Pozor: cena je za pár</p>	 <p>kútový 90° s výstuhou</p>	<p>Biela: 23,-/ bm 1x farba: 26,-/ bm 2x farba: 30,-/ bm</p>
 <p>typ veľké H</p>	<p>Biela: 8,-/ bm 1x farba: 12,-/ bm 2x farba: 14,-/ bm</p>	 <p>kútový 135° s výstuhou</p>	<p>Biela: 24,-/ bm 1x farba: 36,-/bm 2x farba: 50,-/ bm</p>
 <p>statický s výstuhou</p>	<p>Biela: 26,-/ bm 1x farba: 30,-/ bm 2x farba: 32,-/ bm</p>	 <p>statický rúrový s výstuhou</p>	<p>Biela: 36,-/ bm 1x farba: 48,-/ bm 2x farba: 50,-/ bm</p>
 <p>typ pérový</p>	<p>Biela: 3,-/ bm</p>	<p>tyč 6 m</p>	<p>Biela: 3,-/ bm</p>

Poznámka: na doplnkový tovar sa nevzťahuje zľava

DOPLNKOVÝ TOVAR

ALUPLAST IDEAL 4000 a ALUPLAST IDEAL 5000

Rozšiřovací profil s výstuhou: Aluplast	Biela	1 x farba	2 x farba
15 mm	6,-/ bm	8,-/ bm	10,-/ bm
35 mm	8,-/ bm	13,-/ bm	15,-/ bm
60 mm	11,-/ bm	13,-/ bm	16,-/ bm
100 mm	21,-/ bm	23,-/ bm	25,-/ bm

Rozšiřovací profil bez výstuhy: Aluplast	Biela	1 x farba	2 x farba
15 mm	6,-/ bm	8,-/ bm	10,-/ bm
35 mm	6,5,-/ bm	11,5,-/ bm	13,5,-/ bm
60 mm	9,-/ bm	11,-/ bm	14,-/ bm
100 mm	15,-/ bm	17,-/ bm	19,-/ bm

Poznámka: na doplnkový tovar sa nevzťahuje zľava

NETYPIZOVANÉ OKNÁ

Aluplast IDEAL 4000, kovanie Roto NT

Doplatok za trojuholníkové a rôznobežníkové okná + 80 %

Príklad:

FIX v ráme 1000 x 1000

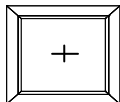

67 €

80 %



Trojuholník fix v ráme 1000 x 1000

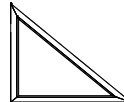

121 €

Sklopka 1000 x 800

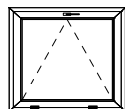

90 €

80 %



Trojuholník sklopka 1000 x 800

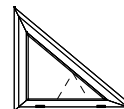

162 €

OS - O 2100 x 1500

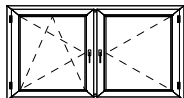

296 €

80 %



Rôznobežník OS - O 2100 x 1500

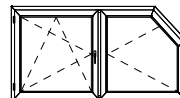

533 €

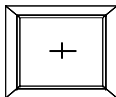

Fix okno v ráme

Aluplast IDEAL 4000

v\š	400	450	500	550	600	650	700	750	800	850	900	950	1000	1050	1100	1150	1200
400	28	29	30	31	32	33	33	34	35	36	37	38	39	40	41	42	43
450	29	30	31	32	32	33	34	35	36	37	38	39	40	42	43	45	46
500	30	31	32	32	33	34	35	36	37	38	39	41	43	44	46	47	49
550	30	31	32	33	34	35	36	36	38	40	42	43	45	47	48	50	52
600	31	32	33	34	35	36	37	38	40	42	44	46	47	49	51	53	55
650	32	33	34	35	35	37	38	40	42	44	46	48	50	52	54	55	57
700	33	34	34	35	36	38	40	42	44	46	48	50	52	54	56	58	60
750	33	34	35	36	38	40	42	44	46	48	50	53	55	57	59	61	63
800	34	35	36	38	40	42	44	46	48	51	53	55	57	59	61	64	66
850	35	36	37	39	41	44	46	48	50	53	55	57	59	62	64	66	68
900	36	36	38	41	43	45	48	50	52	55	57	59	62	64	67	69	71
950	36	37	40	42	45	47	50	52	54	57	59	62	64	67	69	72	74
1000	37	39	41	44	46	49	51	54	56	59	62	64	67	69	72	74	77
1050	38	40	43	45	48	51	53	56	59	61	64	66	69	72	74	77	80
1100	39	41	44	47	50	52	55	58	61	63	66	69	71	74	77	80	82
1150	40	43	46	48	51	54	57	60	63	65	68	71	74	77	79	82	85
1200	41	44	47	50	53	56	59	62	65	68	70	73	76	79	82	85	88
1250	43	46	49	52	55	58	61	64	67	70	73	76	79	82	85	88	91
1300	44	47	50	53	56	59	62	66	69	72	75	78	81	84	87	90	93
1350	45	48	52	55	58	61	64	67	71	74	77	80	83	87	90	93	96
1400	46	50	53	56	60	63	66	69	73	76	79	83	86	89	92	96	99
1450	48	51	54	58	61	65	68	71	75	78	81	85	88	92	95	98	102
1500	49	52	56	59	63	66	70	73	77	80	84	87	91	94	98	101	105
1550	50	54	57	61	65	68	72	75	79	82	86	89	93	97	100	104	107
1600	52	55	59	63	66	70	74	77	81	85	88	92	95	99	103	106	110
1650	53	57	60	64	68	72	75	79	83	87	90	94	98	102	105	109	113
1700	54	58	62	66	70	73	77	81	85	89	93	96	100	104	108	112	116

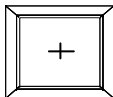

Fix okno v ráme

Aluplast IDEAL 4000

v\š	1250	1300	1350	1400	1450	1500	1550	1600	1650	1700	1750	1800	1850	1900	1950	2000	2050
400	45	46	48	49	51	52	53	55	56	58	59	61	62	63	65	66	68
450	48	49	51	52	54	55	57	58	60	61	63	64	66	67	69	70	72
500	51	52	54	55	57	59	60	62	63	65	67	68	70	71	73	75	76
550	53	55	57	59	60	62	64	65	67	69	70	72	74	76	77	79	81
600	56	58	60	62	64	65	67	69	71	73	74	76	78	80	81	83	85
650	59	61	63	65	67	69	71	72	74	76	78	80	82	84	86	88	89
700	62	64	66	68	70	72	74	76	78	80	82	84	86	88	90	92	94
750	65	67	69	71	73	75	77	79	82	84	86	88	90	92	94	96	98
800	68	70	72	74	77	79	81	83	85	87	90	92	94	96	98	100	103
850	71	73	75	77	80	82	84	87	89	91	93	96	98	100	102	105	107
900	74	76	78	81	83	85	88	90	92	95	97	99	102	104	107	109	111
950	76	79	81	84	86	89	91	94	96	98	101	103	106	108	111	113	116
1000	79	82	84	87	89	92	95	97	100	102	105	107	110	112	115	117	120
1050	82	85	87	90	93	95	98	101	103	106	109	111	114	116	119	122	124
1100	85	88	91	93	96	99	101	104	107	110	112	115	118	121	123	126	129
1150	88	91	94	96	99	102	105	108	111	113	116	119	122	125	127	130	133
1200	91	94	97	100	102	105	108	111	114	117	120	123	126	129	132	135	137
1250	94	97	100	103	106	109	112	115	118	121	124	127	130	133	136	192	196
1300	97	100	103	106	109	112	115	118	121	124	128	131	134	137	194	199	203
1350	99	103	106	109	112	115	119	122	125	128	131	135	191	196	200	205	210
1400	102	106	109	112	115	119	122	125	129	132	135	192	197	202	207	212	217
1450	105	109	112	115	119	122	125	129	132	136	193	198	203	208	213	218	223
1500	108	112	115	118	122	125	129	132	136	194	199	204	209	215	220	225	230
1550	111	114	118	122	125	129	132	136	194	200	205	210	216	221	226	232	237
1600	114	117	121	125	128	132	136	194	200	205	211	216	222	227	233	238	244
1650	117	120	124	128	132	135	194	200	205	211	217	222	228	233	239	245	250
1700	120	123	127	131	135	193	199	205	211	217	222	228	234	240	246	251	257

 - okno s hrúbkou skla 6 mm

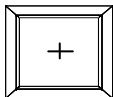

Fix okno v ráme

Aluplast IDEAL 4000

v\š	2100	2150	2200	2250	2300	2350	2400	2450	2500	2550	2600
400	69	70	72	73	75	76	78	79	80	82	83
450	73	75	76	78	80	81	83	84	86	87	89
500	78	80	81	83	84	86	88	89	91	92	94
550	82	84	86	88	89	91	93	94	96	98	99
600	87	89	90	92	94	96	98	99	101	103	105
650	91	93	95	97	99	101	103	105	106	108	110
700	96	98	100	102	104	106	108	110	112	114	116
750	100	102	104	106	109	111	113	115	117	119	121
800	105	107	109	111	113	116	118	120	122	124	126
850	109	111	114	116	118	120	123	125	127	129	132
900	114	116	118	121	123	125	128	130	132	135	137
950	118	120	123	125	128	130	133	135	138	140	142
1000	122	125	128	130	133	135	138	140	195	199	203
1050	127	130	132	135	137	140	196	200	204	207	211
1100	131	134	137	140	196	200	204	208	212	216	220
1150	136	139	195	199	203	208	212	216	220	224	228
1200	194	198	202	207	211	215	219	224	228	232	236
1250	201	205	210	214	218	223	227	232	236	241	245
1300	208	212	217	221	226	231	235	240	244	249	253
1350	215	219	224	229	234	238	243	248	252	257	262
1400	222	226	231	236	241	246	251	256	260	265	270
1450	228	233	238	243	249	254	259	264	269	274	279
1500	235	241	246	251	256	261	266	272	277	282	287
1550	242	248	253	258	264	269	274	280	285	290	296
1600	249	255	260	266	271	277	282	288	293	299	304
1650	256	262	267	273	279	284	290	295	301	307	312
1700	263	269	274	280	286	292	298	303	309	315	321

 - okno s hrúbkou skla 6 mm

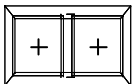

Fix okno v ráme s priečkou

Aluplast IDEAL 4000

v/š	800	850	900	950	1000	1050	1100	1150	1200	1250	1300	1350	1400	1450	1500
400	50	50	51	52	53	54	55	56	56	57	58	59	60	61	62
450	51	52	53	53	54	55	56	57	58	59	60	60	61	62	63
500	52	53	54	55	56	57	57	58	59	60	61	62	63	63	64
550	54	54	55	56	57	58	59	60	60	61	62	63	64	65	66
600	55	56	57	57	58	59	60	61	62	63	63	65	67	68	70
650	56	57	58	59	60	60	61	62	63	64	66	68	70	72	74
700	57	58	59	60	61	62	63	64	66	68	70	72	74	76	78
750	59	60	60	61	62	63	65	67	69	71	73	75	77	80	82
800	60	61	62	63	64	66	68	70	72	75	77	79	81	83	85
850	61	62	63	64	67	69	71	73	76	78	80	82	85	87	89
900	63	64	65	67	70	72	74	77	79	81	84	86	88	91	93
950	64	65	67	70	72	75	77	80	82	85	87	90	92	94	97
1000	65	68	70	73	75	78	80	83	85	88	91	93	96	98	101
1050	68	70	73	76	78	81	83	86	89	91	94	97	99	102	104
1100	70	73	76	78	81	84	87	89	92	95	97	100	103	106	108
1150	73	76	78	81	84	87	90	92	95	98	101	104	106	109	112
1200	75	78	81	84	87	90	93	96	98	101	104	107	110	113	116
1250	78	81	84	87	90	93	96	99	102	105	108	111	114	117	120
1300	80	83	86	90	93	96	99	102	105	108	111	114	117	121	124
1350	83	86	89	92	95	99	102	105	108	111	115	118	121	124	127
1400	85	89	92	95	98	102	105	108	112	115	118	121	125	128	131
1450	88	91	95	98	101	105	108	111	115	118	122	125	128	132	135
1500	90	94	97	101	104	108	111	115	118	122	125	128	132	135	139
1550	93	96	100	103	107	111	114	118	121	125	128	132	136	139	143
1600	95	99	103	106	110	114	117	121	125	128	132	136	139	143	147
1650	98	102	105	109	113	117	120	124	128	132	135	139	143	147	150
1700	100	104	108	112	116	120	123	127	131	135	139	143	146	150	154

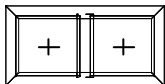

Fix okno v ráme s priečkou

Aluplast IDEAL 4000

v/š	1550	1600	1650	1700	1750	1800	1850	1900	1950	2000	2050	2100	2150	2200	2250
400	63	63	64	65	66	67	68	69	69	70	71	72	73	75	76
450	64	65	66	66	67	68	69	71	72	74	75	77	78	80	81
500	65	66	67	69	71	72	74	75	77	79	80	82	83	85	87
550	68	70	71	73	75	76	78	80	82	83	85	87	88	90	92
600	72	74	75	77	79	81	83	84	86	88	90	92	93	95	97
650	76	78	80	81	83	85	87	89	91	93	95	97	98	100	102
700	80	82	84	86	88	90	92	94	96	98	100	102	104	106	107
750	84	86	88	90	92	94	96	98	100	102	104	106	109	111	113
800	88	90	92	94	96	98	101	103	105	107	109	111	114	116	118
850	91	94	96	98	101	103	105	107	110	112	114	116	119	121	123
900	95	98	100	102	105	107	109	112	114	117	119	121	124	126	128
950	99	102	104	107	109	112	114	116	119	121	124	126	129	131	134
1000	103	106	108	111	113	116	118	121	124	126	129	131	134	136	139
1050	107	110	112	115	118	120	123	126	128	131	133	136	139	141	144
1100	111	114	116	119	122	125	127	130	133	136	138	141	144	146	149
1150	115	118	121	123	126	129	132	135	138	140	143	146	149	152	154
1200	119	122	125	128	131	133	136	139	142	145	148	151	154	157	160
1250	123	126	129	132	135	138	141	144	147	150	153	156	159	162	165
1300	127	130	133	136	139	142	145	148	152	155	158	161	164	167	170
1350	131	134	137	140	143	147	150	153	156	159	163	166	169	172	175
1400	135	138	141	144	148	151	154	158	161	164	167	171	174	177	181
1450	138	142	145	149	152	155	159	162	165	169	172	176	179	182	186
1500	142	146	149	153	156	160	163	167	170	174	177	181	184	187	191
1550	146	150	153	157	161	164	168	171	175	178	182	185	189	193	196
1600	150	154	157	161	165	168	172	176	179	183	187	190	194	198	201
1650	154	158	162	165	169	173	177	180	184	188	192	195	199	203	207
1700	158	162	166	170	173	177	181	185	189	193	196	200	204	208	212

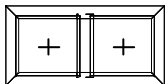

Fix okno v ráme s priečkou

Aluplast IDEAL 4000

v/š	2300	2350	2400	2450	2500	2550	2600	2650	2700	2750	2800	2850	2900	2950	3000
400	78	79	80	82	83	85	86	88	89	90	92	93	95	96	97
450	83	84	86	87	89	90	92	93	95	96	98	99	101	103	104
500	88	90	91	93	95	96	98	99	101	103	104	106	107	109	111
550	94	95	97	99	100	102	104	105	107	109	110	112	114	116	117
600	99	101	102	104	106	108	110	111	113	115	117	119	120	122	124
650	104	106	108	110	112	114	115	117	119	121	123	125	127	129	131
700	109	111	113	115	117	119	121	123	125	127	129	131	133	135	137
750	115	117	119	121	123	125	127	129	131	133	135	138	140	142	144
800	120	122	124	127	129	131	133	135	137	140	142	144	146	148	150
850	125	128	130	132	134	137	139	141	143	146	148	150	152	155	157
900	131	133	135	138	140	142	145	147	149	152	154	157	159	161	164
950	136	138	141	143	146	148	151	153	156	158	160	163	165	168	170
1000	141	144	146	149	151	154	157	159	162	164	167	169	172	174	177
1050	147	149	152	155	157	160	162	165	168	170	173	176	178	181	184
1100	152	155	157	160	163	166	168	171	174	176	179	182	185	187	190
1150	157	160	163	166	169	171	174	177	180	183	185	188	191	194	197
1200	163	165	168	171	174	177	180	183	186	189	192	195	198	200	203
1250	168	171	174	177	180	183	186	189	192	195	198	201	204	207	210
1300	173	176	179	182	186	189	192	195	198	201	204	207	210	214	217
1350	178	182	185	188	191	194	198	201	204	207	210	214	217	220	223
1400	184	187	190	194	197	200	204	207	210	213	217	220	223	227	230
1450	189	192	196	199	203	206	209	213	216	220	223	226	230	233	236
1500	194	198	201	205	208	212	215	219	222	226	229	233	236	240	243
1550	200	203	207	210	214	218	221	225	228	232	235	239	243	246	250
1600	205	209	212	216	220	223	227	231	234	238	242	245	249	253	256
1650	210	214	218	222	225	229	233	237	240	244	248	252	255	259	263
1700	216	220	223	227	231	235	239	243	246	250	254	258	262	266	270

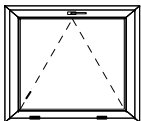

Jednokřídlové okno S

Aluplast IDEAL 4000

Cena dvojsklo

v/š	500	550	600	650	700	750	800	850	900	950	1000	1050	1100	1150	1200	1250	1300	1350	1400	1450	1500	1550	1600
500	57	58	59	61	62	64	66	68	69	73	74	76	78	82	84	86	88	90	93	95	97	100	102
550	58	59	61	62	64	66	67	69	71	74	76	78	80	85	87	90	92	94	96	99	101	104	106
600	60	60	62	64	65	67	69	70	72	76	78	81	83	88	91	93	95	98	100	102	105	108	110
650	61	62	63	65	67	69	70	72	74	79	81	84	86	92	94	96	99	101	104	106	108	112	114
700	63	63	65	66	68	70	72	75	77	82	84	87	89	95	97	100	102	105	107	110	112	116	118
750	64	65	66	68	69	72	75	77	80	85	87	90	93	98	101	103	106	108	111	114	116	120	122
800	66	66	68	69	71	75	77	80	83	88	90	93	96	101	104	107	109	112	115	117	120	124	126

Cena dubová kôra

v/š	500	550	600	650	700	750	800	850	900	950	1000	1050	1100	1150	1200	1250	1300	1350	1400	1450	1500	1550	1600
500	65	65	67	68	70	72	73	75	77	80	82	84	85	90	91	94	96	99	101	104	106	110	112
550	66	66	68	70	71	73	75	77	78	82	83	85	88	93	96	99	101	104	106	109	112	115	118
600	67	68	69	71	73	75	76	78	79	83	86	89	92	98	100	103	106	109	112	114	117	121	124
650	69	69	71	72	74	76	78	79	82	87	90	93	96	102	105	108	111	114	117	120	123	126	129
700	70	71	72	74	75	78	79	83	86	91	94	97	100	106	110	113	116	119	122	125	128	132	135
750	72	72	74	75	77	79	83	86	89	95	98	101	105	111	114	117	121	124	127	130	134	138	141
800	73	74	75	77	79	83	86	89	93	98	102	105	109	115	119	122	125	129	132	136	139	143	147

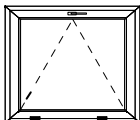

Jednokřídlové okno S

Aluplast IDEAL 4000

Cena mléčného skla

v/š	500	550	600	650	700	750	800	850	900	950	1000	1050	1100	1150	1200	1250	1300	1350	1400	1450	1500	1550	1600	
500	68	69	71	72	74	76	77	79	81	84	86	88	89	94	95	98	101	103	106	109	112	115	118	124
550	70	70	72	74	75	77	79	80	82	86	87	89	92	98	101	103	106	109	112	115	118	121	124	124
600	71	72	73	75	77	79	80	82	83	87	91	94	97	103	106	109	112	115	118	121	124	128	131	131
650	73	73	75	76	78	80	82	83	86	92	95	98	101	108	111	114	117	121	124	127	130	134	138	138
700	74	75	76	78	79	82	83	87	90	96	99	103	106	113	116	120	123	126	130	133	137	141	144	144
750	76	76	78	79	81	83	87	91	94	100	104	107	111	118	121	125	129	132	136	139	143	147	151	151
800	77	78	79	81	83	87	91	95	98	104	108	112	116	123	126	130	134	138	142	146	149	154	158	158

Cena drôtosklo

v/š	500	550	600	650	700	750	800	850	900	950	1000	1050	1100	1150	1200	1250	1300	1350	1400	1450	1500	1550	1600	
500	84	84	86	87	89	91	93	94	96	99	101	103	116	123	126	130	134	137	141	145	148	153	157	157
550	85	86	87	89	90	92	94	96	97	101	114	118	122	129	133	137	141	145	148	152	156	161	165	165
600	86	87	89	90	92	94	95	97	99	116	120	124	128	135	139	144	148	152	156	160	164	169	173	173
650	88	88	90	92	93	95	97	110	115	121	126	130	134	142	146	150	155	159	163	168	172	177	181	181
700	89	90	91	93	95	97	111	115	120	127	131	136	140	148	152	157	162	166	171	175	180	185	189	189
750	91	91	93	94	96	111	116	121	125	132	137	142	147	154	159	164	169	173	178	183	188	193	198	198
800	92	93	94	96	110	116	121	126	131	138	143	148	153	161	166	171	176	180	185	190	195	201	206	206

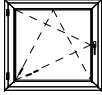

Jednokrídlové okno - OS

Aluplast IDEAL 4000

v/š	550	600	650	700	750	800	850	900	950	1000	1050	1100	1150	1200	1250	1300	1350	1400	1450	1500
600	72	74	76	77	81	82	84	86	91	93	95	98	100	103	105	-	-	-	-	-
650	74	75	77	79	82	84	85	88	93	96	98	101	104	106	108	-	-	-	-	-
700	78	80	82	83	87	89	91	94	99	102	104	107	110	112	115	-	-	-	-	-
750	80	81	83	85	89	91	94	96	102	105	107	110	113	116	118	-	-	-	-	-
800	81	83	84	86	91	94	96	99	105	108	110	113	116	119	122	124	127	-	-	-
850	83	84	86	89	94	96	99	102	108	111	113	116	119	122	125	128	131	-	-	-
900	84	86	88	91	96	99	102	105	111	114	116	119	123	126	128	131	134	-	-	-
950	87	89	92	95	98	101	104	107	113	116	119	122	126	129	132	135	138	142	145	-
1000	89	91	94	97	101	104	107	110	116	119	122	126	129	132	135	138	141	146	149	-
1050	92	95	98	101	105	108	112	115	121	124	127	130	134	137	140	144	147	152	155	-
1100	94	97	101	104	108	111	114	117	124	127	130	134	137	141	144	147	150	155	159	-
1150	96	100	103	106	110	113	117	120	127	130	133	137	140	144	147	151	154	159	162	166
1200	98	102	105	109	113	116	119	123	129	133	136	140	144	147	151	154	157	163	166	170
1250	102	106	110	113	117	121	124	128	134	138	141	145	149	153	156	160	163	168	172	175
1300	105	108	112	115	120	123	127	130	137	141	144	148	152	156	159	163	167	172	176	179
1350	107	110	114	118	122	126	129	133	140	144	147	151	155	159	163	167	170	176	180	183
1400	109	113	116	120	124	128	132	136	143	147	150	154	159	162	166	170	174	179	183	187
1450	111	115	119	123	127	131	135	139	146	150	154	157	162	166	170	174	178	183	187	191
1500	113	117	121	125	129	133	137	141	149	153	157	161	165	169	173	177	181	187	191	195
1550	116	120	124	128	133	137	141	145	152	157	161	165	169	173	178	182	186	192	196	200
1600	118	122	127	131	135	140	144	148	155	159	164	168	173	177	181	185	189	195	200	204
1650	120	125	129	133	138	142	147	151	158	162	167	171	176	180	184	189	193	199	203	208
1700	122	127	131	136	140	145	149	154	161	165	170	174	179	183	188	192	197	203	207	211

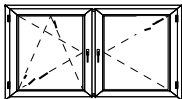

Dvojkřídlové okno OS-O

Aluplast IDEAL 4000

v/š	1000	1050	1100	1150	1200	1250	1300	1350	1400	1450	1500	1550	1600	1650	1700
600	135	138	140	141	142	146	149	151	153	156	159	161	163	165	168
650	140	142	145	146	148	151	154	156	159	161	163	166	168	170	173
700	144	147	149	151	153	156	159	161	163	166	168	171	173	175	178
750	149	151	154	156	158	161	163	166	168	171	173	175	178	181	183
800	153	156	158	161	163	165	168	171	173	175	178	181	183	185	188
850	158	160	163	165	168	170	173	175	178	180	183	185	188	191	193
900	162	164	167	170	172	175	177	180	183	185	187	190	193	195	198
950	172	175	177	180	182	185	187	190	193	195	198	201	203	206	208
1000	182	185	187	190	192	195	197	200	203	205	208	211	213	216	219
1050	186	189	192	194	197	200	202	205	208	210	213	216	218	221	224
1100	191	193	196	199	202	204	207	210	213	215	218	221	223	226	229
1150	195	198	201	204	206	209	212	215	217	220	223	226	228	231	234
1200	199	203	205	208	211	214	217	219	222	225	227	230	233	236	239
1250	204	207	210	213	216	218	221	224	227	230	232	236	238	241	244
1300	208	211	214	217	220	223	226	229	232	234	237	240	243	246	249
1350	213	216	219	222	225	228	230	233	237	240	242	245	248	251	254
1400	217	220	223	226	229	232	235	238	241	244	247	250	253	256	259
1450	222	225	228	231	234	237	240	243	246	249	252	255	258	261	264
1500	226	229	232	236	238	241	244	248	251	254	257	260	263	266	269
1550	231	234	237	240	243	246	249	252	255	259	262	265	268	271	274
1600	235	239	242	245	248	251	254	257	260	264	267	270	273	276	279
1650	246	249	252	255	259	262	265	268	271	275	278	281	284	287	290
1700	256	260	263	266	269	273	276	279	282	286	289	292	295	299	302

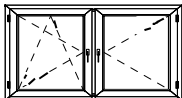

Dvojkřídlové okno OS-O

Aluplast IDEAL 4000

v/š	1750	1800	1850	1900	1950	2000	2050	2100	2150	2200	2250	2300	2350	2400	2450	2500
600	170	172	175	177	179	182	184	186	188	191	193	195	198	200	202	205
650	175	178	180	182	184	187	189	192	194	196	198	201	203	204	207	210
700	180	183	185	187	190	192	194	197	199	202	204	206	207	208	212	216
750	185	188	190	193	195	197	200	202	205	207	210	212	214	215	218	221
800	191	193	195	198	200	203	205	208	210	213	215	218	220	222	225	227
850	195	198	201	203	195	208	210	213	216	218	221	224	226	228	231	233
900	201	203	206	208	211	213	216	218	221	224	226	229	231	234	236	239
950	211	214	216	219	221	224	227	229	232	234	237	240	242	245	248	250
1000	221	224	227	229	232	234	237	240	243	245	248	250	253	256	259	261
1050	227	229	232	235	237	240	243	245	248	251	253	256	259	262	264	267
1100	232	234	237	240	243	245	248	251	253	256	259	262	264	267	270	272
1150	237	239	242	245	248	251	253	256	259	262	264	267	270	273	276	278
1200	242	244	247	250	253	256	259	261	264	267	270	273	276	278	281	285
1250	247	250	253	255	258	261	264	267	270	273	277	280	284	287	291	294
1300	252	255	258	261	264	266	270	272	275	279	283	287	290	294	298	301
1350	257	260	263	266	269	272	275	278	281	285	289	293	297	300	304	308
1400	262	265	268	271	274	277	280	284	287	291	296	299	303	307	311	315
1450	267	270	273	276	279	283	286	290	294	297	302	306	310	314	318	321
1500	272	275	278	282	285	288	292	296	300	304	308	312	316	320	324	328
1550	277	280	284	287	292	296	300	304	308	312	317	321	325	329	333	337
1600	282	288	289	293	297	301	306	310	314	318	323	327	331	336	340	344
1650	294	297	300	304	307	310	313	316	320	324	329	334	338	342	346	351
1700	305	308	311	315	318	321	324	328	331	334	337	341	344	349	353	357

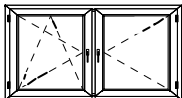

Dvojkřídlové okno so štulpom OS-O

Aluplast IDEAL 4000

v/š	1000	1050	1100	1150	1200	1250	1300	1350	1400	1450	1500	1550	1600	1650	1700
600	153	154	156	158	159	161	162	164	167	169	171	172	174	175	177
650	156	157	159	161	162	164	165	167	170	172	174	175	177	179	181
700	162	163	165	167	168	170	171	173	176	178	180	182	185	187	190
750	165	166	168	170	171	173	174	176	180	182	185	187	190	193	195
800	168	169	171	173	174	176	177	180	185	187	190	193	195	198	201
850	172	174	175	177	179	181	183	186	191	194	197	199	202	205	208
900	180	182	184	185	188	190	193	196	201	204	207	210	213	216	218
950	185	186	188	191	194	197	200	203	206	209	212	215	218	221	224
1000	188	189	192	195	198	201	204	207	211	214	217	220	223	226	230
1050	194	196	200	203	206	209	212	215	219	222	225	229	232	235	238
1100	197	201	204	207	211	214	217	220	224	227	231	234	237	240	244
1150	202	205	208	212	215	218	222	225	229	232	236	239	242	246	249
1200	206	209	213	216	220	223	227	230	234	237	241	244	248	251	255
1250	213	216	220	223	227	231	234	238	242	245	249	252	256	259	263
1300	217	221	224	228	232	235	239	242	247	250	254	258	261	265	268
1350	221	225	229	232	236	240	244	247	252	255	259	263	267	270	274
1400	226	229	233	237	241	245	248	252	257	260	264	268	272	276	280
1450	231	235	239	243	247	251	255	259	263	267	271	275	279	283	287
1500	236	240	244	248	252	256	260	264	268	272	276	280	284	288	292
1550	241	245	249	253	257	261	266	270	274	278	282	287	291	295	299
1600	245	249	253	258	262	266	270	274	279	283	288	292	296	300	304
1650	249	254	258	262	267	271	275	279	284	288	293	297	301	306	310
1700	254	258	262	267	271	275	280	284	289	293	298	302	307	311	315

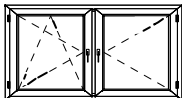

Dvojkřídlové okno so štulpom OS-O

Aluplast IDEAL 4000

v/š	1750	1800	1850	1900	1950	2000	2050	2100	2150	2200	2250	2300	2350	2400	2450	2500
600	179	181	190	192	194	197	199	201	204	206	209	211	214	216	218	-
650	184	187	196	198	200	203	205	208	210	213	215	218	220	223	225	-
700	192	196	204	207	209	212	214	217	220	222	225	228	230	233	235	-
750	198	202	210	213	215	218	221	223	226	228	232	234	237	239	242	-
800	203	207	216	219	221	224	227	230	232	235	238	241	244	246	249	252
850	211	214	223	226	229	232	235	237	240	243	246	249	252	255	257	260
900	221	225	234	237	240	243	246	249	252	254	258	261	264	267	269	272
950	227	231	240	243	246	249	252	255	258	261	264	267	270	273	276	279
1000	233	237	246	249	252	255	258	261	264	267	271	274	277	280	283	286
1050	241	245	255	258	261	264	267	271	274	277	281	284	287	290	293	296
1100	247	251	261	264	267	270	274	277	280	283	287	290	294	297	300	303
1150	252	257	266	270	273	276	280	283	287	290	294	297	300	304	307	310
1200	258	263	272	276	279	282	286	289	293	296	300	304	307	311	314	317
1250	266	271	281	284	288	291	295	298	302	306	310	313	317	320	324	327
1300	272	277	287	290	294	297	301	305	308	312	316	320	323	327	331	334
1350	278	282	292	296	300	303	307	311	315	318	323	326	330	334	338	341
1400	283	288	298	302	306	310	313	317	321	325	329	333	337	341	344	348
1450	291	296	306	309	313	317	321	325	329	333	337	341	345	349	353	357
1500	296	301	311	315	319	323	327	331	335	339	344	348	352	356	360	364
1550	303	308	318	322	326	331	335	339	343	347	352	356	360	364	368	372
1600	308	314	324	328	332	337	341	345	349	353	358	362	366	371	375	379
1650	314	319	330	334	338	343	347	351	356	360	365	369	373	378	382	386
1700	320	325	336	340	344	349	353	358	362	366	371	376	380	384	389	393

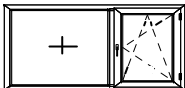

Dvojdielne okno Fix+OS

Aluplast IDEAL 4000

v/š	1600	1650	1700	1750	1800	1850	1900	1950	2000	2050	2100	2150
600	116	117	119	121	124	128	130	132	134	136	138	140
650	119	121	123	125	128	133	135	137	139	141	143	146
700	126	129	131	133	136	141	143	145	147	150	152	154
750	131	133	136	138	141	146	148	150	153	155	157	160
800	135	138	140	143	146	151	153	155	158	160	163	165
850	140	142	145	147	151	156	158	161	163	166	168	171
900	144	147	150	152	156	161	163	166	168	171	174	176
950	149	152	154	157	161	166	168	171	174	176	179	182
1000	154	156	159	162	166	171	173	176	179	182	185	187
1050	160	163	166	169	172	177	180	183	186	189	192	195
1100	164	167	170	173	177	182	185	188	191	194	197	200
1150	169	172	175	178	182	187	191	194	197	200	203	206
1200	173	177	180	183	187	192	196	199	202	205	208	212
1250	180	183	187	190	194	199	203	206	209	213	216	219
1300	185	188	191	195	199	204	208	211	215	218	221	225
1350	189	193	196	199	204	209	213	216	220	223	227	230
1400	194	197	201	204	209	214	218	222	225	229	232	236
1450	198	202	206	209	214	220	223	227	230	234	238	241
1500	203	206	210	214	219	224	228	232	236	239	243	247
1550	208	212	216	220	225	231	234	238	242	246	250	254
1600	213	217	221	225	230	236	240	243	247	251	255	259
1650	217	221	225	230	235	241	245	249	253	257	261	265
1700	222	226	230	234	239	246	250	254	258	262	266	270

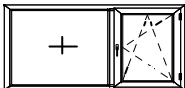

Dvojdielne okno Fix+OS

Aluplast IDEAL 4000

v/š	2200	2250	2300	2350	2400	2450	2500	2550	2600	2650	2700
600	142	145	147	149	151	153	-	-	-	-	-
650	148	150	152	155	157	159	-	-	-	-	-
700	156	159	161	164	166	168	-	-	-	-	-
750	162	165	167	169	172	174	-	-	-	-	-
800	168	171	173	175	178	180	183	185	188	190	-
850	173	176	179	181	184	186	189	192	194	197	-
900	179	182	185	187	190	193	195	198	200	203	-
950	185	188	191	193	196	199	201	204	207	210	214
1000	190	194	196	199	202	205	208	210	213	216	221
1050	198	201	204	207	210	213	216	218	221	224	229
1100	203	207	210	213	216	219	222	225	228	231	236
1150	209	213	216	219	222	225	228	231	234	237	242
1200	215	218	222	225	228	231	234	237	241	244	249
1250	222	226	229	233	236	239	243	246	249	252	257
1300	228	232	235	239	242	245	249	252	255	259	264
1350	234	238	241	245	248	251	255	258	262	265	271
1400	239	243	247	250	254	258	261	265	268	272	277
1450	245	249	253	256	260	264	267	271	275	278	284
1500	251	255	259	262	266	270	274	277	281	285	290
1550	257	262	266	269	273	277	281	285	289	292	298
1600	263	268	271	275	279	283	287	291	295	299	305
1650	269	273	277	281	285	289	293	297	301	305	311
1700	274	279	283	287	291	295	300	304	308	312	318

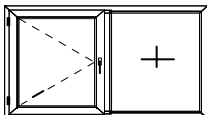

Dvojdielne O-Fix

Aluplast IDEAL 4000

v/š	1400	1450	1500	1550	1600	1650	1700	1750	1800	1850	1900	1950	2000	2050
600	102	104	106	107	109	111	112	114	116	122	124	126	128	130
650	106	107	109	111	112	114	116	119	121	127	129	131	133	135
700	109	111	112	114	117	119	121	123	126	132	134	136	138	141
750	112	114	117	119	121	124	126	128	131	137	139	141	144	146
800	116	118	121	123	126	128	131	133	135	142	144	147	149	151
850	120	123	125	128	130	133	135	138	140	147	149	152	154	157
900	124	127	130	132	135	137	140	143	145	152	154	157	160	162
950	128	131	134	137	139	142	145	147	150	157	159	162	165	168
1000	133	135	138	141	144	147	149	152	155	162	164	167	170	173
1050	139	141	144	147	150	153	156	159	162	168	171	174	177	180
1100	143	146	149	152	155	158	161	164	167	174	177	180	183	185
1150	147	150	153	156	159	162	166	169	172	179	182	185	188	191
1200	151	154	157	161	164	167	170	173	177	184	187	190	193	196
1250	156	159	163	166	169	172	176	179	182	189	193	196	199	202
1300	160	164	167	170	174	177	180	184	187	194	198	201	204	208
1350	164	168	171	175	178	182	185	189	192	199	203	206	210	213
1400	169	172	176	179	183	186	190	193	197	204	208	211	215	218
1450	173	176	180	184	187	191	195	198	202	209	213	217	220	224
1500	177	181	184	188	192	196	199	203	207	214	218	222	225	229
1550	182	186	190	194	197	201	205	209	213	220	224	228	232	236
1600	186	190	194	198	202	206	210	214	218	225	229	233	237	241
1650	190	194	199	202	207	211	215	219	223	230	234	238	242	246
1700	195	199	203	207	211	215	219	223	228	235	240	244	248	252

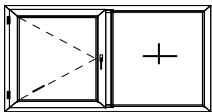

Dvojdielne O-Fix

Aluplast IDEAL 4000

v/š	2100	2150	2200	2250	2300	2350	2400	2450	2500	2550	2600	2650	2700
600	132	134	136	138	140	142	144	146	148	150	153	155	157
650	137	140	142	144	146	148	150	153	155	157	159	161	163
700	143	145	147	150	152	154	156	159	161	163	165	168	170
750	148	151	153	155	158	160	162	165	167	169	172	174	176
800	154	156	159	161	164	166	168	171	173	176	178	181	183
850	159	162	164	167	169	172	174	177	180	182	185	187	190
900	165	167	170	173	175	178	181	183	186	188	191	194	196
950	170	173	176	178	181	184	186	189	192	195	197	200	203
1000	176	179	181	184	187	190	193	195	198	201	204	207	209
1050	183	186	189	192	195	197	200	203	206	209	212	215	218
1100	188	192	195	197	200	203	206	209	212	215	218	221	224
1150	194	197	200	203	206	209	212	216	219	222	225	228	231
1200	199	203	206	209	212	215	219	222	225	228	231	234	238
1250	206	209	212	215	219	222	225	229	232	235	238	242	245
1300	211	214	218	221	225	228	231	235	238	241	245	248	251
1350	217	220	223	227	230	234	237	241	244	248	251	255	258
1400	222	226	229	233	236	240	243	247	250	254	258	261	265
1450	228	231	235	238	242	246	249	253	257	260	264	268	271
1500	233	237	240	244	248	252	255	259	263	267	270	274	278
1550	240	243	247	251	255	259	263	266	270	274	278	282	286
1600	245	249	253	257	261	265	269	273	276	280	284	288	292
1650	250	255	259	263	267	271	275	279	283	287	291	295	299
1700	256	260	264	268	272	277	281	285	289	293	297	301	305

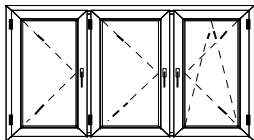

Trojkrídlové okno O-O-OS

Aluplast IDEAL 4000

v/š	2200	2250	2300	2350	2400	2450	2500	2550	2600	2650	2700	2750	2800	2850
700	236	238	240	243	245	248	250	252	254	257	259	262	265	267
750	243	245	248	250	253	255	257	260	262	264	267	270	273	276
800	250	252	255	257	260	262	264	267	269	272	274	279	281	284
850	257	260	262	265	267	269	272	274	277	279	281	287	290	292
900	264	267	269	272	274	277	279	282	284	286	289	295	298	301
950	279	281	284	286	289	291	294	296	299	301	304	306	309	312
1000	293	296	298	301	303	306	308	311	314	316	319	321	324	327
1050	300	303	305	308	311	313	316	319	321	324	326	329	332	334
1100	307	310	313	315	318	321	323	326	328	331	334	336	339	342
1150	314	317	320	322	325	328	331	333	336	339	341	344	347	349
1200	321	324	327	329	332	335	338	340	343	346	349	351	354	357
1250	328	331	334	337	339	342	345	348	351	353	356	361	365	369
1300	336	338	341	344	347	350	352	355	358	361	363	370	373	377
1350	343	346	348	351	354	357	360	363	365	368	371	378	382	385
1400	350	353	355	358	361	364	367	370	373	376	378	386	390	394
1450	357	360	363	366	368	371	374	377	380	383	386	394	398	402
1500	364	367	370	373	375	379	382	385	387	390	393	403	407	411
1550	371	374	377	380	383	386	389	392	395	398	404	414	418	422
1600	378	381	384	387	390	393	396	399	402	405	412	423	427	431
1650	395	398	401	404	407	410	413	416	419	423	426	431	435	439
1700	411	415	418	421	424	427	430	433	437	440	443	446	449	452

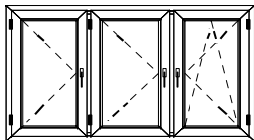

Trojkrídlové okno O-O-OS

Aluplast IDEAL 4000

v/š	2900	2950	3000	3050	3100	3150	3200	3250	3300
700	270	272	275	277	280	282	285	287	290
750	278	281	283	286	289	291	294	296	299
800	287	289	292	295	297	300	303	306	308
850	295	298	301	304	306	309	312	315	318
900	304	307	309	312	315	318	321	324	327
950	314	317	319	322	324	327	330	333	336
1000	329	332	334	337	339	342	344	347	350
1050	337	339	342	345	347	350	354	357	360
1100	344	347	350	353	356	359	363	366	369
1150	352	355	358	362	365	368	372	375	378
1200	360	364	367	370	374	377	381	384	388
1250	372	376	379	383	386	390	393	397	400
1300	381	384	388	392	395	399	402	406	410
1350	389	393	397	400	404	408	412	415	419
1400	398	401	405	409	413	417	421	424	428
1450	406	410	414	418	422	426	430	434	437
1500	415	419	423	427	431	435	439	443	447
1550	427	431	435	439	443	447	451	455	459
1600	435	439	443	448	452	456	460	464	469
1650	444	448	452	456	461	465	469	474	478
1700	455	458	462	465	470	474	478	483	487

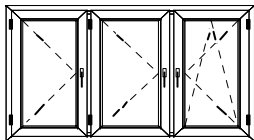

Trojkrídlové okno so štulpom O-O-OS

Aluplast IDEAL 4000

v/š	2200	2250	2300	2350	2400	2450	2500	2550	2600	2650	2700	2750	2800	2850
700	248	250	252	255	257	260	262	265	267	275	277	286	288	291
750	255	257	260	263	265	268	270	273	276	283	286	294	297	300
800	262	265	268	270	273	276	278	281	284	292	294	303	306	308
850	271	274	277	280	282	285	288	291	294	301	304	313	316	319
900	284	287	290	292	295	298	301	304	307	315	318	326	329	332
950	291	294	297	300	303	306	309	312	315	323	326	335	338	341
1000	299	302	305	308	311	314	317	320	323	332	335	344	347	350
1050	311	314	317	320	324	327	330	333	336	345	348	357	360	363
1100	319	322	325	328	332	335	338	341	345	353	356	365	369	372
1150	326	329	333	336	339	343	346	349	353	361	365	374	377	381
1200	333	337	340	344	347	351	354	358	361	370	373	382	386	389
1250	344	348	352	355	359	362	366	369	373	381	385	394	398	401
1300	352	356	359	363	366	370	374	377	381	390	393	403	406	410
1350	359	363	367	370	374	378	382	385	389	398	402	411	415	419
1400	367	371	374	378	382	386	390	394	397	406	410	420	424	427
1450	376	380	384	388	392	396	399	403	407	416	420	430	434	438
1500	383	387	391	395	399	403	407	411	415	425	429	438	442	446
1550	393	397	401	405	409	414	418	422	426	435	439	449	453	457
1600	401	405	409	413	417	422	426	430	434	443	448	458	462	466
1650	408	412	417	421	425	429	434	438	442	452	456	466	470	475
1700	415	420	424	429	433	437	442	446	450	460	464	475	479	483

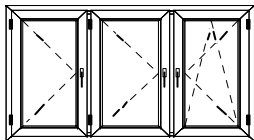

Trojkrídlové okno so štulpom O-O-OS

Aluplast IDEAL 4000

v/š	2900	2950	3000	3050	3100	3150	3200	3250	3300
700	293	296	298	301	303	306	309	311	314
750	302	305	307	310	313	315	318	320	323
800	311	314	316	319	322	324	327	330	333
850	321	324	327	330	332	335	338	341	344
900	335	338	341	344	347	350	353	355	358
950	344	347	350	353	356	359	362	365	368
1000	353	356	359	362	365	368	371	374	377
1050	366	369	373	376	379	382	385	389	392
1100	375	378	382	385	388	391	395	398	401
1150	384	387	391	394	397	401	404	407	411
1200	393	396	400	403	406	410	413	417	420
1250	405	408	412	416	419	423	426	430	433
1300	414	417	421	425	428	432	436	439	443
1350	422	426	430	434	437	441	445	449	452
1400	431	435	439	443	447	450	454	458	462
1450	442	446	450	453	457	461	465	469	473
1500	450	454	458	462	466	470	475	479	483
1550	461	466	470	474	478	482	486	490	494
1600	470	474	479	483	487	491	495	500	504
1650	479	483	488	492	496	500	505	509	513
1700	488	492	496	501	505	510	514	518	523

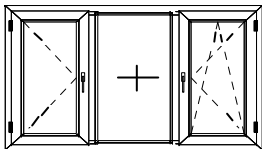

Trojdielné okno O-Fix-OS

Aluplast IDEAL 4000

v/š	1600	1650	1700	1750	1800	1850	1900	1950	2000	2050	2100	2150	2200	2250
700	168	169	171	173	175	176	178	180	181	183	187	189	190	192
750	172	174	175	177	179	181	182	184	186	188	191	194	196	198
800	176	178	180	181	183	185	187	189	191	193	198	200	203	205
850	180	182	184	186	188	189	192	194	197	199	204	207	209	212
900	185	186	188	190	192	195	198	200	203	206	211	213	216	219
950	190	192	194	197	200	203	205	208	211	214	217	220	223	226
1000	195	197	200	203	206	209	211	214	217	220	224	226	229	232
1050	203	206	209	212	215	218	221	224	227	230	234	237	240	243
1100	209	212	215	218	221	224	227	230	233	237	240	243	246	249
1150	214	218	221	224	227	230	233	237	240	243	247	250	253	256
1200	220	223	226	230	233	236	240	243	246	249	253	256	260	263
1250	228	232	235	238	242	245	248	252	255	258	262	266	269	272
1300	234	237	241	244	248	251	254	258	261	265	269	272	276	279
1350	239	243	246	250	254	257	261	264	268	271	275	279	282	286
1400	245	249	252	256	259	263	267	270	274	278	282	285	289	293
1450	250	254	258	262	265	269	273	277	280	284	288	292	296	300
1500	256	260	264	268	271	275	279	283	287	290	295	299	302	306
1550	264	268	272	276	279	283	287	291	295	299	303	307	311	315
1600	269	273	277	281	285	289	293	297	301	305	310	314	318	322
1650	275	279	283	287	291	295	300	304	308	312	316	321	325	329
1700	280	285	289	293	297	301	306	310	314	318	323	327	331	336

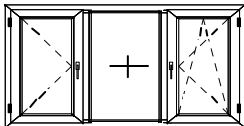

Trojdielné okno O-Fix-OS

Aluplast IDEAL 4000

v/š	2300	2350	2400	2450	2500	2550	2600	2650	2700	2750	2800	2850	2900	2950
700	194	196	199	201	203	206	208	210	214	222	224	227	229	231
750	201	203	206	208	211	213	215	218	221	230	232	234	237	239
800	208	210	213	215	218	220	223	225	229	237	240	242	245	247
850	215	217	220	222	225	228	230	233	237	245	248	250	253	255
900	221	224	227	230	232	235	238	240	244	253	255	258	261	263
950	228	231	234	237	240	242	245	248	252	260	263	266	269	272
1000	235	238	241	244	247	250	253	255	259	268	271	274	277	280
1050	246	249	252	255	258	261	263	266	270	279	282	285	288	291
1100	252	256	259	262	265	268	271	274	278	287	290	293	296	299
1150	259	262	266	269	272	275	278	282	286	295	298	301	304	307
1200	266	269	273	276	279	283	286	289	293	302	306	309	312	316
1250	276	279	283	286	289	293	296	299	304	313	316	320	323	326
1300	283	286	290	293	296	300	303	307	311	321	324	328	331	334
1350	290	293	297	300	304	307	311	314	319	328	332	335	339	342
1400	296	300	304	307	311	315	318	322	327	336	340	343	347	351
1450	303	307	311	314	318	322	326	329	334	344	347	351	355	359
1500	310	314	318	322	325	329	333	337	342	351	355	359	363	367
1550	319	323	327	331	335	339	343	347	352	361	365	369	373	377
1600	326	330	334	338	342	346	350	354	359	369	373	377	381	385
1650	333	337	341	345	349	353	358	362	367	377	381	385	389	393
1700	340	344	348	352	357	361	365	369	374	384	389	393	397	401

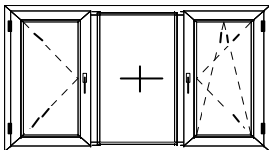

Trojdielné okno O-Fix-OS

Aluplast IDEAL 4000

v/š	3000	3050	3100	3150	3200	3250	3300
700	234	236	238	241	243	245	248
750	242	244	247	249	251	254	256
800	250	252	255	257	260	263	265
850	258	261	263	266	269	271	274
900	266	269	272	274	277	280	282
950	274	277	280	283	286	288	291
1000	282	285	288	291	294	297	300
1050	294	297	300	303	306	309	312
1100	302	306	309	312	315	318	321
1150	311	314	317	320	323	327	330
1200	319	322	325	329	332	335	338
1250	330	333	336	340	343	347	350
1300	338	341	345	348	352	355	359
1350	346	350	353	357	360	364	367
1400	354	358	361	365	369	372	376
1450	362	366	370	374	377	381	385
1500	371	374	378	382	386	390	394
1550	381	385	389	393	397	401	404
1600	389	393	397	401	405	409	413
1650	397	401	405	410	414	418	422
1700	405	410	414	418	422	426	431

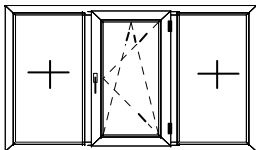

Trojdielne okno Fix-OS-Fix

Aluplast IDEAL 4000

v/š	2200	2250	2300	2350	2400	2450	2500	2550	2600	2650	2700	2750	2800	2850
700	155	158	160	162	164	166	168	170	173	176	180	182	184	186
750	161	164	166	168	170	173	175	177	179	183	187	189	192	194
800	168	170	172	175	177	179	182	184	186	190	194	197	199	201
850	174	176	179	181	184	186	188	191	193	197	201	204	206	209
900	180	182	185	188	190	193	195	198	200	204	208	211	213	216
950	186	189	191	194	197	199	202	204	207	211	215	218	221	223
1000	192	195	198	200	203	206	208	211	214	218	222	225	228	231
1050	200	203	206	209	211	214	217	220	223	226	231	234	237	240
1100	206	209	212	215	218	221	224	227	229	233	238	241	244	247
1150	212	215	218	221	224	227	230	233	236	240	245	248	251	254
1200	219	222	225	228	231	234	237	240	243	247	253	256	259	262
1250	227	230	233	236	239	243	246	249	252	256	262	265	268	271
1300	233	236	239	243	246	249	252	256	259	263	269	272	275	279
1350	239	242	246	249	252	256	259	263	266	270	276	279	282	286
1400	245	249	252	256	259	262	266	269	273	277	283	286	290	293
1450	251	255	258	262	266	269	273	276	280	284	290	293	297	301
1500	257	261	265	268	272	276	279	283	287	291	297	301	304	308
1550	265	268	272	276	280	283	287	291	295	299	305	309	313	316
1600	271	275	279	282	286	290	294	298	302	306	312	316	320	324
1650	277	281	285	289	293	297	301	305	308	313	319	323	327	331
1700	283	287	291	295	299	303	307	311	315	320	326	330	334	338

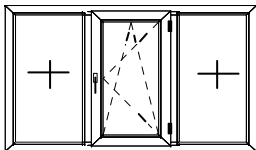

Trojdielne okno Fix-OS-Fix

Aluplast IDEAL 4000

v/š	2900	2950	3000	3050	3100	3150	3200	3250	3300
700	189	191	193	195	197	199	202	204	206
750	196	198	201	203	205	207	210	212	215
800	204	206	208	211	213	215	218	220	223
850	211	213	216	218	221	223	226	228	231
900	218	221	223	226	229	231	234	236	239
950	226	229	231	234	236	239	242	244	247
1000	233	236	239	241	244	247	250	252	256
1050	243	245	248	251	254	257	259	262	266
1100	250	253	256	259	262	265	267	270	274
1150	257	260	263	266	269	272	275	278	282
1200	265	268	271	274	277	280	283	287	290
1250	274	278	281	284	287	290	294	297	300
1300	282	285	288	292	295	298	301	305	309
1350	289	293	296	299	303	306	309	313	317
1400	297	300	304	307	311	314	318	321	325
1450	304	308	311	315	318	322	326	329	333
1500	312	315	319	323	326	330	334	337	341
1550	320	324	328	331	335	339	343	346	351
1600	328	331	335	339	343	347	351	355	359
1650	335	339	343	347	351	355	359	363	367
1700	342	347	351	355	359	363	367	371	375

Balkónové dvere OS

Aluplast IDEAL 4000

v/š	600	650	700	750	800	850	900	950	1000
1800	133	138	142	147	152	157	161	169	173
1850	136	140	145	150	155	159	164	172	176
1900	138	142	147	152	157	162	167	175	179
1950	146	151	156	161	166	171	176	183	188
2000	148	153	158	163	168	173	178	186	191
2050	150	155	160	166	171	176	181	189	194
2100	153	158	163	168	174	179	184	192	197
2150	155	160	165	171	176	181	187	195	200
2200	157	163	168	174	179	184	190	198	203
2250	159	165	170	176	182	187	192	201	206
2300	162	167	173	179	184	190	195	204	209
2350	164	169	175	181	187	192	198	206	212
2400	166	172	177	184	189	195	201	209	215

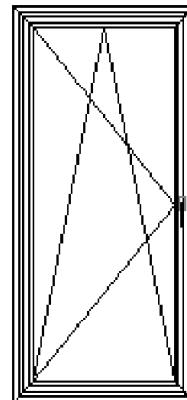

Balkónové dvere O

Aluplast IDEAL 4000

v/š	600	650	700	750	800	850	900	950	1000
1800	122	127	131	136	140	145	149	158	162
1850	124	129	134	138	143	148	152	161	165
1900	126	131	136	141	145	150	155	164	168
1950	132	137	142	147	151	156	161	170	175
2000	134	139	144	149	154	159	164	173	177
2050	136	141	146	151	157	162	167	175	180
2100	139	144	149	154	159	164	169	178	183
2150	141	146	151	156	162	167	172	181	186
2200	143	148	154	159	164	170	175	184	189
2250	145	151	156	161	167	172	178	187	192
2300	147	153	158	164	169	175	180	190	195
2350	150	155	161	166	172	177	183	192	198
2400	152	157	163	169	174	180	186	195	201

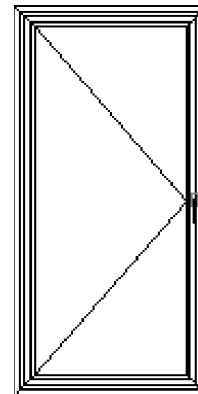

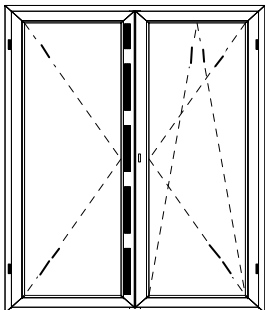

Balkónové dvere so štulpom O-OS

Aluplast IDEAL 4000

v/š	1400	1450	1500	1550	1600	1650	1700	1750	1800	1850	1900	1950	2000	2050	2100
1800	304	309	313	318	322	327	331	336	342	352	357	361	366	371	375
1850	309	314	318	323	328	332	337	342	347	358	363	367	372	377	381
1900	314	319	323	328	333	338	342	347	353	364	369	373	378	383	388
1950	329	334	339	344	349	354	358	363	369	380	385	390	395	399	404
2000	334	339	344	349	354	359	364	369	375	386	391	396	401	406	411
2050	339	344	349	354	359	364	369	374	381	392	397	402	407	412	417
2100	344	349	355	360	365	370	375	380	386	397	403	408	413	418	423
2150	349	354	360	365	370	375	380	386	392	403	409	414	419	424	429
2200	354	360	365	370	376	381	386	392	398	409	415	420	425	431	436
2250	359	365	370	376	381	386	392	397	404	415	421	426	431	437	442
2300	364	370	375	381	386	392	397	403	409	421	426	432	437	443	448
2350	369	375	381	386	392	397	403	408	415	427	432	438	444	449	455
2400	374	380	386	391	397	403	408	414	421	433	438	444	450	455	461

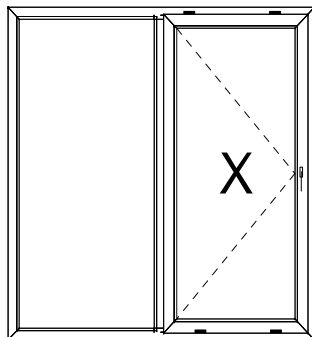

Posuvné dvere Aluplast IDEAL 4000 RL manuálny posuv

v/š	1800	1850	1900	1950	2000	2050	2100	2150	2200	2250	2300	2350	2400	2450	2500
1800	404	407	409	411	424	426	429	432	434	436	449	451	453	456	458
1850	408	410	413	415	428	430	432	435	438	440	453	455	457	460	462
1900	411	413	416	418	431	433	436	439	441	444	456	458	461	463	466
1950	415	417	420	422	435	438	440	443	446	448	461	463	466	468	471
2000	418	420	423	425	438	441	443	446	449	451	464	467	469	472	474
2050	421	423	426	428	441	444	446	450	452	455	467	470	473	475	478
2100	424	427	429	432	445	447	450	453	456	459	471	474	477	479	482
2150	427	429	432	435	448	451	453	456	459	462	475	477	480	483	485
2200	430	432	435	438	451	454	456	460	462	465	478	481	483	486	489
2250	433	435	438	441	454	457	460	463	466	469	481	484	487	490	492
2300	435	438	441	444	457	460	463	466	469	472	485	488	490	493	496
2350	439	442	445	448	461	464	467	470	473	476	489	492	495	498	501
2400	-	-	448	451	464	467	470	474	477	479	492	495	498	501	504

Poznámka: na posuvné dvere Aluplast IDEAL 4000 RL manuálny posuv sa nevzťahuje zľava

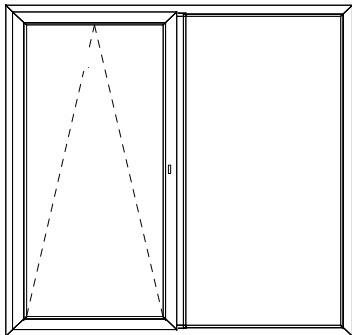

Posuvné dvere Aluplast IDEAL 4000 RL automatic

v/š	1800	1850	1900	1950	2000	2050	2100	2150	2200	2250	2300	2350	2400	2450	2500
1800	598	600	603	605	614	616	618	621	623	626	638	640	643	645	647
1850	601	603	606	608	617	619	622	624	626	629	641	644	646	648	651
1900	604	606	609	611	620	622	625	627	630	632	645	647	650	652	654
1950	607	609	612	614	623	626	628	631	633	636	648	651	653	656	658
2000	610	612	615	617	626	629	631	634	636	639	651	654	657	659	662
2050	612	615	617	620	629	631	634	636	639	642	654	657	659	662	665
2100	615	618	620	623	632	634	637	640	642	645	658	660	663	665	668
2150	618	620	623	626	635	637	640	643	645	648	661	664	666	669	672
2200	621	623	626	629	638	641	643	646	649	651	664	667	670	672	675
2250	624	627	630	633	642	645	647	650	653	656	669	671	674	677	680
2300	627	630	633	636	645	648	650	653	656	659	672	675	678	680	683
2350	-	-	-	-	648	651	654	657	659	662	675	678	681	684	687
2400	-	-	-	-	651	654	657	660	663	666	679	682	684	687	690

Poznámka: na posuvné dvere Aluplast IDEAL 4000 RL automatic sa nevzťahuje zľava

Aluplast IDEAL 5000

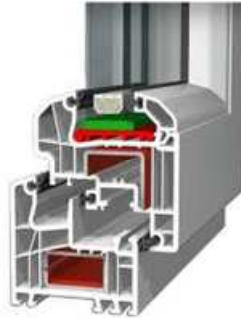

- 5 komorový profil
- stavebná hĺbka 70 mm
- výška rámu 80 mm
- trojité dorazové vymeniteľné tesnenie
- kovanie WinkHaus
- oceľová pozinkovaná výstuha
- izolačné dvojsklo plnené argónom
- koeficient $U_f = 1,1 \text{ W/m}^2\text{K}$

VZORKY FARIEB

ALUPLAST IDEAL 5000

Aluplast

Štandardné farby:

Príplatky za farbu:	vonkajšiu	+ 22 %
	vnútornú	+ 29 %
	obojsstrannú	+ 42 %



Poznámka: neštandardné farby v profile Aluplast sa individuálne vycenenia podľa počtu kusov

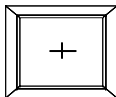

Fix okno v krídle

Aluplast IDEAL 5000

vš	400	450	500	550	600	650	700	750	800	850	900	950	1000	1050	1100	1150	1200
400	42	44	46	48	50	52	54	56	58	60	62	64	66	68	70	72	74
450	43	45	48	50	52	54	56	58	60	62	64	66	68	70	72	74	76
500	45	47	49	51	54	56	58	60	62	64	66	68	70	72	74	76	78
550	47	49	51	53	55	58	60	62	64	66	68	70	72	74	76	79	81
600	49	51	53	55	57	59	61	64	66	68	70	72	74	77	80	82	85
650	51	53	55	57	59	61	63	65	68	70	72	75	77	80	83	86	88
700	53	55	57	59	61	63	65	67	69	72	75	78	81	83	86	89	92
750	55	57	59	61	63	65	67	69	72	75	78	81	84	87	89	92	95
800	57	59	61	63	65	67	69	72	75	78	81	84	87	90	93	96	99
850	59	61	63	65	67	69	72	75	78	81	84	87	90	93	96	99	102
900	61	63	65	67	69	71	75	78	81	84	87	90	93	96	99	102	105
950	63	65	67	69	71	74	77	80	84	87	90	93	96	99	103	106	109
1000	65	67	69	71	73	77	80	83	86	90	93	96	99	103	106	109	112
1050	67	69	71	73	76	79	83	86	89	93	96	99	103	106	109	113	116
1100	69	71	73	75	78	82	85	89	92	95	99	102	106	109	113	116	119
1150	70	73	75	77	81	84	88	91	95	98	102	105	109	112	116	119	123
1200	72	74	77	80	84	87	91	94	98	101	105	108	112	116	119	123	126
1250	74	76	79	82	86	90	93	97	101	104	108	111	115	119	122	126	130
1300	76	78	81	85	89	92	96	100	103	107	111	115	118	122	126	129	133
1350	78	80	84	87	91	95	99	102	106	110	114	118	121	125	129	133	137
1400	80	82	86	90	94	97	101	105	109	113	117	121	125	128	132	136	140
1450	82	84	88	92	96	100	104	108	112	116	120	124	128	132	136	140	143
1500	84	87	91	95	99	103	107	111	115	119	123	127	131	135	139	143	147
1550	86	89	93	97	101	105	109	114	118	122	126	130	134	138	142	146	150
1600	88	91	95	100	104	108	112	116	120	125	129	133	137	141	145	150	154
1650	90	94	98	102	106	111	115	119	123	128	132	136	140	145	149	153	157
1700	92	96	100	104	109	113	117	122	126	130	135	139	143	148	152	156	161

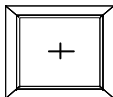

Fix okno v krídle

Aluplast IDEAL 5000

v\š	1250	1300	1350	1400	1450	1500	1550	1600	1650	1700	1750	1800	1850	1900	1950	2000	2050
400	76	78	80	82	84	86	88	91	93	95	97	99	101	104	106	108	111
450	78	80	82	84	87	89	91	94	96	99	101	103	106	108	111	113	116
500	80	83	85	88	90	93	95	98	100	103	105	108	110	113	115	118	120
550	84	87	89	92	94	97	99	102	104	107	110	112	115	117	120	122	125
600	87	90	93	95	98	101	103	106	109	111	114	117	119	122	124	127	130
650	91	94	96	99	102	105	107	110	113	115	118	121	124	126	129	132	135
700	95	97	100	103	106	109	111	114	117	120	122	125	128	131	134	136	139
750	98	101	104	107	110	112	115	118	121	124	127	130	133	135	138	141	144
800	102	105	107	110	113	116	119	122	125	128	131	134	137	140	143	146	149
850	105	108	111	114	117	120	123	126	129	132	135	138	141	144	147	150	153
900	109	112	115	118	121	124	127	130	133	137	140	143	146	149	152	155	158
950	112	115	119	122	125	128	131	134	138	141	144	147	150	153	157	160	163
1000	116	119	122	125	129	132	135	138	142	145	148	151	155	158	161	164	168
1050	119	123	126	129	133	136	139	143	146	149	153	156	159	162	166	169	172
1100	123	126	130	133	136	140	143	147	150	153	157	160	164	167	170	174	177
1150	126	130	133	137	140	144	147	151	154	158	161	165	168	172	175	178	182
1200	130	133	137	140	144	148	151	155	158	162	165	169	172	176	180	183	187
1250	133	137	141	144	148	151	155	159	162	166	170	173	177	181	184	225	230
1300	137	141	144	148	152	155	159	163	166	170	174	178	181	185	227	232	236
1350	140	144	148	152	156	159	163	167	171	174	178	182	223	228	233	238	243
1400	144	148	152	155	159	163	167	171	175	179	183	224	229	234	239	245	250
1450	147	151	155	159	163	167	171	175	179	183	225	230	235	241	246	251	256
1500	151	155	159	163	167	171	175	179	183	226	231	236	241	247	252	257	263
1550	154	159	163	167	171	175	179	183	226	231	237	242	248	253	258	264	269
1600	158	162	166	170	175	179	183	226	231	237	243	248	254	259	265	270	276
1650	161	166	170	174	178	183	226	231	237	243	248	254	260	265	271	277	282
1700	165	169	174	178	182	225	231	237	243	248	254	260	266	272	277	283	289

 - okno s hrúbkou skla 6 mm

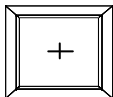

Fix okno v krídle

Aluplast IDEAL 5000

v\š	2100	2150	2200	2250	2300	2350	2400	2450	2500	2550	2600
400	113	115	118	120	122	125	127	129	132	134	136
450	118	120	123	125	128	130	132	135	137	140	142
500	123	125	128	130	133	135	138	140	143	145	148
550	128	130	133	135	138	140	143	146	148	151	153
600	132	135	138	140	143	146	148	151	154	156	159
650	137	140	143	145	148	151	154	156	159	162	164
700	142	145	148	150	153	156	159	162	164	167	170
750	147	150	153	155	158	161	164	167	170	173	176
800	152	155	158	161	163	166	169	172	175	178	181
850	156	160	163	166	169	172	175	178	181	184	187
900	161	164	168	171	174	177	180	183	186	189	192
950	166	169	173	176	179	182	185	188	192	195	198
1000	171	174	177	181	184	187	191	194	233	237	241
1050	176	179	182	186	189	192	233	237	241	245	249
1100	181	184	187	191	232	236	240	244	249	253	257
1150	185	189	230	234	239	243	248	252	256	261	265
1200	228	232	237	241	246	251	255	260	264	269	273
1250	234	239	244	249	253	258	263	267	272	277	281
1300	241	246	251	256	260	265	270	275	280	284	289
1350	248	253	258	263	268	273	277	282	287	292	297
1400	255	260	265	270	275	280	285	290	295	300	305
1450	261	267	272	277	282	287	292	298	303	308	313
1500	268	273	279	284	289	295	300	305	311	316	321
1550	275	280	286	291	296	302	307	313	318	324	329
1600	281	287	293	298	304	309	315	320	326	332	337
1650	288	294	300	305	311	317	322	328	334	339	345
1700	295	301	306	312	318	324	330	336	341	347	353

 - okno s hrúbkou skla 6 mm

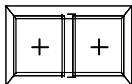

Fix okno v krídle s priečkou v ráme

Aluplast IDEAL 5000

v/š	800	850	900	950	1000	1050	1100	1150	1200	1250	1300	1350	1400	1450	1500
400	81	83	85	87	89	91	93	96	98	100	102	104	106	108	110
450	85	87	89	91	93	95	97	99	101	103	105	107	109	111	113
500	88	90	92	95	97	99	101	103	105	107	109	111	113	115	117
550	92	94	96	98	100	102	104	106	108	110	112	114	116	119	121
600	96	98	100	102	104	106	108	110	112	114	116	118	120	122	124
650	99	101	103	105	107	109	111	113	115	118	120	122	124	126	128
700	103	105	107	109	111	113	115	117	119	121	123	125	127	129	131
750	106	108	110	112	114	117	119	121	123	125	127	129	131	133	136
800	110	112	114	116	118	120	122	124	126	128	130	132	135	138	141
850	113	115	118	120	122	124	126	128	130	132	134	137	140	143	146
900	117	119	121	123	125	127	129	131	133	136	139	142	146	149	152
950	121	123	125	127	129	131	133	135	138	141	144	148	151	154	157
1000	124	126	128	130	132	134	136	140	143	146	149	153	156	159	162
1050	128	130	132	134	136	138	141	144	148	151	154	158	161	164	168
1100	131	133	135	137	139	142	146	149	153	156	159	163	166	170	173
1150	135	137	139	141	144	147	151	154	157	161	164	168	171	175	178
1200	138	141	143	145	148	152	155	159	162	166	169	173	177	180	184
1250	142	144	146	149	153	156	160	164	167	171	174	178	182	185	189
1300	146	148	150	153	157	161	165	168	172	176	180	183	187	191	194
1350	149	151	154	158	162	166	169	173	177	181	185	188	192	196	200
1400	153	155	159	162	166	170	174	178	182	186	190	193	197	201	205
1450	156	159	163	167	171	175	179	183	187	191	195	199	202	206	210
1500	160	163	167	171	175	179	183	188	192	196	200	204	208	212	216
1550	164	168	172	176	180	184	188	192	196	200	205	209	213	217	221
1600	168	172	176	180	185	189	193	197	201	205	210	214	218	222	226
1650	172	176	181	185	189	193	198	202	206	210	215	219	223	227	232
1700	176	181	185	189	194	198	202	207	211	215	220	224	228	233	237

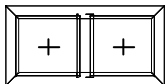

Fix okno v krídle s priečkou v ráme

Aluplast IDEAL 5000

v/š	1550	1600	1650	1700	1750	1800	1850	1900	1950	2000	2050	2100	2150	2200	2250
400	112	114	116	118	120	122	124	126	128	130	132	134	136	138	140
450	115	118	120	122	124	126	128	130	132	134	136	138	140	142	144
500	119	121	123	125	127	129	131	133	135	137	139	142	144	146	148
550	123	125	127	129	131	133	135	137	139	141	143	145	148	150	153
600	126	128	130	132	134	136	138	141	144	146	149	152	154	157	160
650	130	132	134	136	139	142	144	147	150	152	155	158	161	163	166
700	133	136	139	142	145	147	150	153	156	158	161	164	167	170	172
750	139	142	144	147	150	153	156	159	162	165	167	170	173	176	179
800	144	147	150	153	156	159	162	165	168	171	174	177	179	182	185
850	149	153	156	159	162	165	168	171	174	177	180	183	186	189	192
900	155	158	161	164	167	170	174	177	180	183	186	189	192	195	198
950	160	163	167	170	173	176	179	183	186	189	192	195	198	202	205
1000	166	169	172	175	179	182	185	188	192	195	198	201	205	208	211
1050	171	174	178	181	184	188	191	194	198	201	204	208	211	214	218
1100	176	180	183	187	190	194	197	200	204	207	211	214	217	221	224
1150	182	185	189	192	196	199	203	206	210	213	217	220	224	227	231
1200	187	191	194	198	201	205	209	212	216	219	223	226	230	234	237
1250	193	196	200	204	207	211	214	218	222	225	229	233	236	240	244
1300	198	202	205	209	213	217	220	224	228	231	235	239	243	246	250
1350	203	207	211	215	219	222	226	230	234	238	241	245	249	253	257
1400	209	213	217	220	224	228	232	236	240	244	247	251	255	259	263
1450	214	218	222	226	230	234	238	242	246	250	254	258	262	266	269
1500	220	224	228	232	236	240	244	248	252	256	260	264	268	272	276
1550	225	229	233	237	241	246	250	254	258	262	266	270	274	278	282
1600	230	235	239	243	247	251	255	260	264	268	272	276	280	285	289
1650	236	240	244	249	253	257	261	266	270	274	278	283	287	291	295
1700	241	246	250	254	259	263	267	272	276	280	284	289	293	297	302

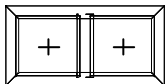

Fix okno v krídle s priečkou v ráme

Aluplast IDEAL 5000

v/š	2300	2350	2400	2450	2500	2550	2600	2650	2700	2750	2800	2850	2900	2950	3000
400	143	145	147	149	151	153	155	157	159	161	163	165	167	169	171
450	146	148	150	152	154	156	158	160	162	164	167	169	171	174	176
500	150	152	154	157	159	162	164	167	169	171	174	176	179	181	184
550	156	158	161	163	166	168	171	174	176	179	181	184	186	189	192
600	162	165	167	170	173	175	178	181	183	186	189	191	194	196	199
650	169	171	174	177	180	182	185	188	190	193	196	199	201	204	207
700	175	178	181	184	186	189	192	195	198	200	203	206	209	212	214
750	182	185	188	190	193	196	199	202	205	208	210	213	216	219	222
800	188	191	194	197	200	203	206	209	212	215	218	221	224	227	230
850	195	198	201	204	207	210	213	216	219	222	225	228	231	234	237
900	201	204	208	211	214	217	220	223	226	229	232	235	239	242	245
950	208	211	214	217	221	224	227	230	233	237	240	243	246	249	252
1000	214	218	221	224	228	231	234	237	241	244	247	250	254	257	260
1050	221	224	228	231	234	238	241	244	248	251	254	258	261	264	268
1100	228	231	234	238	241	245	248	251	255	258	262	265	268	272	275
1150	234	238	241	245	248	252	255	258	262	265	269	272	276	279	283
1200	241	244	248	251	255	258	262	266	269	273	276	280	283	287	290
1250	247	251	254	258	262	265	269	273	276	280	284	287	291	294	298
1300	254	257	261	265	269	272	276	280	283	287	291	295	298	302	306
1350	260	264	268	272	275	279	283	287	291	294	298	302	306	310	313
1400	267	271	275	278	282	286	290	294	298	302	305	309	313	317	321
1450	273	277	281	285	289	293	297	301	305	309	313	317	321	325	329
1500	280	284	288	292	296	300	304	308	312	316	320	324	328	332	336
1550	286	291	295	299	303	307	311	315	319	323	327	332	336	340	344
1600	293	297	301	305	310	314	318	322	326	331	335	339	343	347	351
1650	300	304	308	312	317	321	325	329	333	338	342	346	350	355	359
1700	306	310	315	319	323	328	332	336	341	345	349	354	358	362	367

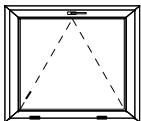

Jednokřídlové okno S

Aluplast IDEAL 5000

Cena dvojsklo

v/š	500	550	600	650	700	750	800	850	900	950	1000	1050	1100	1150	1200	1250	1300	1350	1400	1450	1500	1550	1600
500	62	63	65	67	69	72	74	76	78	82	84	86	88	93	95	97	99	102	104	107	109	112	115
550	64	65	67	69	71	74	76	78	80	84	86	88	90	95	98	100	103	106	108	111	113	116	119
600	66	67	69	71	73	76	78	80	82	86	88	91	93	99	101	104	107	109	112	114	117	120	123
650	68	69	71	73	75	78	80	82	84	89	91	94	97	102	105	108	110	113	116	118	121	124	127
700	70	71	73	75	77	79	81	84	87	92	94	97	100	105	108	111	114	117	119	122	125	128	131
750	72	73	75	77	79	81	84	87	90	95	98	101	103	109	112	115	117	120	123	126	129	132	135
800	73	75	77	79	81	84	87	90	93	98	101	104	107	112	115	118	121	124	127	130	133	136	139

Cena dubová kôra

v/š	500	550	600	650	700	750	800	850	900	950	1000	1050	1100	1150	1200	1250	1300	1350	1400	1450	1500	1550	1600
500	68	69	71	73	75	78	80	82	84	88	90	92	94	99	101	103	106	108	111	114	117	120	123
550	70	71	73	75	77	80	82	84	86	90	92	94	96	102	105	108	110	113	116	119	122	125	128
600	72	73	75	77	79	82	84	86	88	92	94	97	100	106	109	112	115	118	121	124	127	131	134
650	74	75	77	79	81	84	86	88	90	95	98	101	105	110	113	117	120	123	126	129	132	136	139
700	76	77	79	81	83	86	88	90	94	99	102	105	109	115	118	121	124	128	131	134	138	141	145
750	78	79	81	83	85	87	91	94	97	103	106	110	113	119	122	126	129	132	136	139	143	147	150
800	80	81	83	85	87	90	94	98	101	107	110	114	117	123	127	130	134	137	141	144	148	152	156

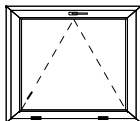

Jednokrídlové okno S

Aluplast IDEAL 5000

Cena mliečne sklo

v/š	500	550	600	650	700	750	800	850	900	950	1000	1050	1100	1150	1200	1250	1300	1350	1400	1450	1500	1550	1600
500	71	72	74	76	78	81	83	85	87	91	93	95	97	102	104	106	109	112	115	118	121	124	127
550	73	74	76	78	80	83	85	87	89	93	95	97	100	105	108	111	114	117	121	124	127	130	134
600	75	76	78	80	82	85	87	89	91	95	98	101	104	110	113	116	120	123	126	129	133	136	140
650	77	78	80	82	84	87	89	91	93	99	102	105	109	115	118	122	125	128	132	135	138	143	146
700	79	80	82	84	86	89	91	94	97	103	106	110	114	120	123	127	130	134	137	141	144	149	152
750	81	82	84	86	88	91	94	98	101	107	111	114	118	124	128	132	135	139	143	147	150	155	158
800	83	84	86	88	90	94	98	102	106	111	115	119	123	129	133	137	141	145	148	152	156	161	164

Cena drôtosklo

v/š	500	550	600	650	700	750	800	850	900	950	1000	1050	1100	1150	1200	1250	1300	1350	1400	1450	1500	1550	1600
500	90	91	93	95	97	100	102	104	106	110	112	114	128	134	139	143	147	151	155	159	164	168	173
550	92	93	95	97	99	102	104	106	108	112	126	130	134	141	146	150	154	159	163	167	172	177	181
600	94	95	97	99	101	104	106	108	110	127	132	136	141	148	153	157	162	166	171	176	180	185	190
650	96	97	99	101	103	106	108	122	126	133	138	143	148	155	160	165	169	174	179	184	188	194	199
700	98	99	101	103	105	107	122	127	132	139	144	149	154	162	167	172	177	182	187	192	197	202	207
750	100	101	103	105	107	122	127	133	138	145	150	156	161	169	174	179	184	189	195	200	205	211	216
800	102	103	105	107	121	127	133	138	144	151	156	162	167	175	181	186	192	197	203	208	213	219	225

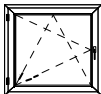

Jednokrídlové okno - OS

Aluplast IDEAL 5000

v/š	550	600	650	700	750	800	850	900	950	1000	1050	1100	1150	1200	1250	1300	1350	1400	1450	1500
600	77	79	81	83	87	89	91	93	98	101	103	106	109	112	114	-	-	-	-	-
650	79	81	83	85	89	91	93	96	101	104	107	109	112	115	118	-	-	-	-	-
700	84	86	88	90	94	96	99	101	107	110	112	115	118	121	124	-	-	-	-	-
750	86	88	90	92	96	99	101	104	110	113	116	118	122	125	128	-	-	-	-	-
800	88	90	92	94	98	101	104	107	113	116	119	122	125	128	131	134	137	-	-	-
850	90	92	94	96	101	104	107	110	116	119	122	125	129	132	135	138	141	-	-	-
900	92	94	96	99	104	107	110	113	119	122	125	128	132	135	138	141	144	-	-	-
950	95	97	100	103	107	110	113	116	122	125	129	132	135	138	142	145	148	153	156	-
1000	97	99	103	106	110	113	116	119	125	128	132	135	139	142	145	148	152	156	160	-
1050	100	103	107	110	114	117	120	124	130	133	136	140	144	147	150	154	157	162	165	-
1100	103	106	109	113	117	120	123	127	133	136	140	143	147	150	154	157	161	165	169	-
1150	105	108	112	115	119	123	126	130	136	139	143	146	150	154	157	161	164	169	173	176
1200	107	111	115	118	122	126	129	133	139	143	146	150	154	157	161	164	168	173	177	180
1250	112	115	119	123	127	130	134	138	144	147	151	155	159	162	166	170	173	179	182	186
1300	114	118	122	125	129	133	137	141	147	151	154	158	162	166	170	173	177	182	186	190
1350	117	120	124	128	132	136	140	144	150	154	158	161	166	169	173	177	181	186	190	194
1400	119	123	127	131	135	139	143	147	153	157	161	165	169	173	177	181	184	190	194	198
1450	121	125	129	133	138	142	146	149	156	160	164	168	172	176	180	184	188	194	197	201
1500	124	128	132	136	140	144	148	152	159	163	167	171	176	180	184	188	192	197	201	205
1550	127	131	136	140	144	148	152	156	163	167	171	175	180	184	188	192	196	202	206	210
1600	130	134	138	142	147	151	155	159	166	170	175	179	183	188	192	196	200	206	210	214
1650	132	136	141	145	150	154	158	162	169	174	178	182	187	191	195	199	204	210	214	218
1700	135	139	143	148	152	157	161	165	172	177	181	185	190	194	199	203	207	213	218	222

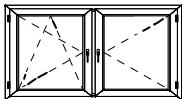

Dvojkřídlové okno OS-O

Aluplast IDEAL 5000

v/š	1000	1050	1100	1150	1200	1250	1300	1350	1400	1450	1500	1550	1600	1650	1700
600	144	146	148	150	152	154	156	158	162	164	166	168	170	172	174
650	147	149	151	153	155	158	160	162	165	167	169	171	174	176	178
700	153	156	158	160	162	164	166	168	172	174	176	178	180	183	186
750	157	159	161	163	165	167	169	171	175	177	180	183	186	189	192
800	161	163	165	167	169	171	173	175	180	183	186	188	191	194	197
850	164	166	168	170	172	174	177	180	185	188	191	194	197	200	203
900	168	170	172	174	176	179	182	185	190	193	196	199	202	205	209
950	173	175	177	179	182	185	188	192	195	198	201	205	208	211	214
1000	176	178	180	184	187	190	193	197	200	204	207	210	213	217	220
1050	183	185	188	191	195	198	201	205	209	212	215	219	222	225	229
1100	186	189	193	196	200	203	206	210	214	217	221	224	227	231	234
1150	191	194	198	201	205	208	211	215	219	222	226	229	233	236	240
1200	195	199	202	206	209	213	217	220	224	228	231	235	238	242	245
1250	202	206	209	213	217	220	224	228	232	235	239	243	246	250	253
1300	207	210	214	218	221	225	229	233	237	240	244	248	252	255	259
1350	211	215	219	223	226	230	234	238	242	246	250	253	257	261	265
1400	216	220	224	227	231	235	239	243	247	251	255	259	263	266	270
1450	220	224	228	232	236	240	244	248	252	256	260	264	268	272	276
1500	225	229	233	237	241	245	249	253	257	261	265	270	274	278	282
1550	231	235	240	244	248	252	256	260	265	269	273	277	281	285	289
1600	236	240	244	248	253	257	261	265	270	274	278	282	286	291	295
1650	240	245	249	253	257	262	266	270	275	279	283	288	292	296	300
1700	245	249	254	258	262	267	271	275	280	284	289	293	297	302	306

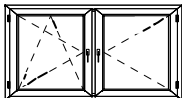

Dvojkřídlové okno OS-O

Aluplast IDEAL 5000

v/š	1750	1800	1850	1900	1950	2000	2050	2100	2150	2200	2250	2300	2350	2400	2450	2500
600	176	179	186	189	191	194	197	199	202	205	208	210	213	216	218	-
650	180	184	192	195	197	200	203	206	208	211	214	217	220	222	225	-
700	189	193	200	203	206	209	212	214	217	220	223	226	229	232	234	-
750	195	198	206	209	212	215	218	221	223	226	230	233	235	238	241	-
800	200	204	212	215	218	221	224	227	230	233	236	239	242	245	248	251
850	206	210	218	221	224	227	230	233	236	239	243	246	249	252	255	258
900	212	216	224	227	230	233	236	239	242	246	249	252	255	258	261	265
950	217	221	230	233	236	239	242	246	249	252	256	259	262	265	268	271
1000	223	227	236	239	242	245	249	252	255	258	262	265	269	272	275	278
1050	232	236	245	248	251	254	258	261	264	268	272	275	278	282	285	288
1100	238	242	250	254	257	261	264	267	271	274	278	281	285	288	292	295
1150	243	248	256	260	263	267	270	274	277	281	285	288	291	295	298	302
1200	249	253	262	266	269	273	276	280	283	287	291	295	298	302	305	309
1250	257	262	270	274	278	281	285	289	292	296	300	303	307	311	314	318
1300	263	267	276	280	284	287	291	295	298	302	306	310	314	317	321	325
1350	268	273	282	286	290	293	297	301	305	309	313	317	320	324	328	332
1400	274	279	288	292	296	299	303	307	311	315	319	323	327	331	335	339
1450	280	285	294	298	302	306	310	313	317	321	326	330	334	338	341	345
1500	286	290	300	304	308	312	316	320	324	328	332	336	340	344	348	352
1550	293	298	307	311	316	320	324	328	332	336	341	345	349	353	357	361
1600	299	304	313	317	322	326	330	334	338	342	347	351	355	360	364	368
1650	305	310	319	323	328	332	336	340	345	349	353	358	362	366	370	375
1700	310	316	325	329	334	338	342	347	351	355	360	364	369	373	377	382

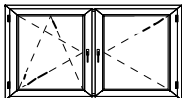

Dvojkřídlové okno so štulpom OS-O

Aluplast IDEAL 5000

v/š	1000	1050	1100	1150	1200	1250	1300	1350	1400	1450	1500	1550	1600	1650	1700
600	158	160	162	164	166	168	170	172	176	178	180	182	184	186	188
650	161	163	165	168	170	172	174	176	179	182	184	186	188	190	192
700	168	170	172	174	176	178	180	182	186	188	190	192	195	198	201
750	171	173	175	177	179	181	183	185	189	192	195	198	201	204	206
800	175	177	179	181	183	185	187	190	194	197	200	203	206	209	212
850	180	182	184	186	188	190	193	196	201	204	207	210	213	216	219
900	188	190	192	194	196	199	203	206	211	214	217	220	223	226	229
950	192	195	197	199	203	206	209	212	216	219	222	225	228	232	235
1000	196	198	201	204	207	211	214	217	221	224	227	231	234	237	241
1050	202	205	208	212	215	218	222	225	229	232	235	239	242	245	249
1100	206	210	213	217	220	223	227	230	234	237	241	244	248	251	254
1150	211	214	218	221	225	228	232	235	239	243	246	250	253	257	260
1200	215	219	223	226	230	233	237	240	244	248	251	255	259	262	266
1250	222	226	230	233	237	241	244	248	252	256	259	263	267	270	274
1300	227	231	235	238	242	246	249	253	257	261	265	268	272	276	279
1350	232	235	239	243	247	251	254	258	262	266	270	274	278	281	285
1400	236	240	244	248	252	256	259	263	268	271	275	279	283	287	291
1450	242	246	250	254	258	262	266	270	274	278	282	286	290	294	298
1500	247	251	255	259	263	267	271	275	279	283	287	291	295	299	304
1550	252	256	261	265	269	273	277	281	286	290	294	298	302	306	310
1600	257	261	265	270	274	278	282	286	291	295	299	303	307	312	316
1650	262	266	270	274	279	283	287	291	296	300	304	309	313	317	321
1700	266	270	275	279	283	288	292	296	301	305	310	314	318	323	327

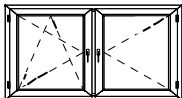

Dvojkřídlové okno so štulpom OS-O

Aluplast IDEAL 5000

v/š	1750	1800	1850	1900	1950	2000	2050	2100	2150	2200	2250	2300	2350	2400	2450	2500
600	190	193	201	204	206	209	212	214	217	219	223	225	228	230	233	-
650	195	199	207	210	212	215	218	220	223	226	229	232	234	237	240	-
700	204	207	215	218	221	224	227	229	232	235	238	241	244	247	249	-
750	209	213	221	224	227	230	233	236	238	241	245	248	250	253	256	-
800	215	219	227	230	233	236	239	242	245	248	251	254	257	260	263	266
850	222	226	234	237	240	243	246	249	253	256	259	262	265	268	271	274
900	232	236	245	248	251	254	257	260	263	266	270	273	276	279	282	285
950	238	242	251	254	257	260	263	266	270	273	276	280	283	286	289	292
1000	244	248	257	260	263	266	270	273	276	279	283	286	289	293	296	299
1050	252	256	265	268	272	275	278	282	285	288	292	295	299	302	305	309
1100	258	262	271	274	278	281	285	288	291	295	299	302	305	309	312	316
1150	264	268	277	280	284	287	291	294	298	301	305	309	312	315	319	322
1200	269	274	283	286	290	293	297	300	304	308	312	315	319	322	326	329
1250	277	282	291	295	298	302	305	309	313	316	320	324	328	331	335	339
1300	283	288	297	301	304	308	312	315	319	323	327	331	334	338	342	346
1350	289	294	303	307	310	314	318	322	325	329	333	337	341	345	349	352
1400	295	299	309	313	316	320	324	328	332	336	340	344	348	352	355	359
1450	302	307	316	320	324	328	332	336	340	344	348	352	356	360	364	368
1500	308	312	322	326	330	334	338	342	346	350	354	358	362	366	370	374
1550	314	319	329	333	337	341	345	349	353	357	362	366	370	374	378	382
1600	320	325	335	339	343	347	351	355	360	364	368	373	377	381	385	389
1650	326	331	340	345	349	353	357	362	366	370	375	379	383	388	392	396
1700	331	337	346	351	355	359	364	368	372	377	381	386	390	394	399	403

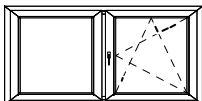

Dvojdielne okno Fix+OS

Aluplast IDEAL 5000

v/š	1600	1650	1700	1750	1800	1850	1900	1950	2000	2050	2100	2150
600	152	154	156	158	161	165	167	170	173	175	178	181
650	156	158	160	163	166	171	173	176	179	182	184	187
700	162	165	168	171	175	179	182	185	188	190	193	196
750	168	171	174	177	180	185	188	191	194	196	199	202
800	173	176	179	182	186	191	194	197	200	203	206	209
850	179	182	185	188	192	197	200	203	206	209	212	215
900	184	187	191	194	198	203	206	209	212	215	218	221
950	190	193	196	199	203	208	212	215	218	221	224	227
1000	195	199	202	205	209	214	218	221	224	227	231	234
1050	202	206	209	212	217	222	225	228	232	235	238	242
1100	208	211	215	218	222	227	231	234	238	241	245	248
1150	213	217	220	224	228	233	237	240	244	247	251	254
1200	219	222	226	229	234	239	243	246	250	253	257	261
1250	226	230	233	237	241	247	250	254	258	261	265	269
1300	231	235	239	243	247	253	256	260	264	268	271	275
1350	237	241	244	248	253	259	262	266	270	274	278	281
1400	242	246	250	254	259	264	268	272	276	280	284	288
1450	248	252	256	260	265	270	274	278	282	286	290	294
1500	253	257	261	265	270	276	280	284	288	292	296	300
1550	260	264	268	272	277	283	287	291	295	299	303	307
1600	265	269	274	278	283	289	293	297	301	305	310	314
1650	271	275	279	283	289	295	299	303	307	312	316	320
1700	276	281	285	289	294	300	305	309	313	318	322	326

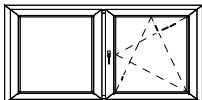

Dvojdielne okno Fix+OS

Aluplast IDEAL 5000

v/š	2200	2250	2300	2350	2400	2450	2500	2550	2600	2650	2700
600	183	186	189	192	194	197	-	-	-	-	-
650	190	193	196	198	201	204	-	-	-	-	-
700	199	202	205	208	210	213	-	-	-	-	-
750	205	208	211	214	217	220	-	-	-	-	-
800	211	215	218	221	224	227	230	233	236	238	-
850	218	221	224	227	230	233	236	239	243	246	-
900	224	228	231	234	237	240	243	246	249	253	-
950	231	234	237	241	244	247	250	253	257	260	264
1000	237	241	244	247	250	254	257	260	264	267	272
1050	245	249	252	255	259	262	265	269	272	275	280
1100	251	255	259	262	265	269	272	276	279	282	287
1150	258	262	265	269	272	276	279	283	286	290	294
1200	264	268	272	275	279	282	286	289	293	297	302
1250	272	276	280	284	287	291	295	298	302	305	311
1300	279	283	287	290	294	298	301	305	309	313	318
1350	285	289	293	297	301	304	308	312	316	320	325
1400	291	296	300	303	307	311	315	319	323	327	332
1450	298	302	306	310	314	318	322	326	330	334	339
1500	304	309	313	317	321	325	329	333	337	341	346
1550	312	316	320	324	328	333	337	341	345	349	354
1600	318	323	327	331	335	339	343	348	352	356	362
1650	324	329	333	338	342	346	350	354	359	363	369
1700	331	335	340	344	348	353	357	361	366	370	376

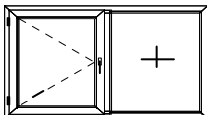

Dvojdielne O-Fix

Aluplast IDEAL 5000

v/š	1400	1450	1500	1550	1600	1650	1700	1750	1800	1850	1900	1950	2000	2050
600	138	140	142	144	146	148	150	152	154	160	162	165	168	170
650	142	144	146	148	150	152	154	157	160	166	168	171	174	176
700	145	147	149	151	154	157	160	162	165	171	174	177	180	183
750	149	151	154	157	160	162	165	168	171	177	180	183	186	189
800	153	156	159	162	165	168	171	174	177	183	186	189	192	195
850	158	161	164	167	170	174	177	180	183	189	192	195	198	201
900	164	167	170	173	176	179	182	185	188	195	198	201	204	207
950	169	172	175	178	181	185	188	191	194	201	204	207	210	213
1000	174	177	180	184	187	190	193	197	200	206	210	213	216	219
1050	181	184	187	191	194	197	201	204	207	214	217	221	224	227
1100	186	189	193	196	199	203	206	210	213	220	223	227	230	233
1150	191	194	198	201	205	208	212	215	219	226	229	233	236	240
1200	196	200	203	207	210	214	217	221	225	231	235	239	242	246
1250	202	206	209	213	216	220	224	227	231	238	242	245	249	253
1300	207	211	214	218	222	226	229	233	237	244	248	251	255	259
1350	212	216	220	224	227	231	235	239	243	250	253	257	261	265
1400	217	221	225	229	233	237	241	244	248	256	259	263	267	271
1450	223	227	230	234	238	242	246	250	254	261	265	269	273	277
1500	228	232	236	240	244	248	252	256	260	267	271	275	279	283
1550	234	238	242	246	250	254	258	263	267	274	278	282	286	290
1600	239	243	247	252	256	260	264	268	272	280	284	288	292	297
1650	244	248	253	257	261	265	270	274	278	286	290	294	298	303
1700	249	254	258	262	267	271	275	280	284	292	296	300	305	309

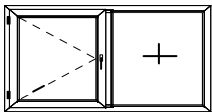

Dvojdielne O-Fix

Aluplast IDEAL 5000

v/š	2100	2150	2200	2250	2300	2350	2400	2450	2500	2550	2600	2650	2700
600	173	175	178	181	183	186	189	191	194	197	199	202	205
650	179	182	185	187	190	193	195	198	201	204	206	209	212
700	185	188	191	194	197	199	202	205	208	210	213	216	219
750	192	194	197	200	203	206	209	212	215	217	220	223	226
800	198	201	204	207	210	213	215	218	221	224	227	230	233
850	204	207	210	213	216	219	222	225	228	231	234	237	240
900	210	213	216	220	223	226	229	232	235	238	241	244	247
950	217	220	223	226	229	232	236	239	242	245	248	251	255
1000	223	226	229	232	236	239	242	246	249	252	255	259	262
1050	231	234	237	241	244	247	251	254	257	261	264	267	271
1100	237	240	244	247	250	254	257	261	264	267	271	274	278
1150	243	247	250	253	257	260	264	267	271	274	278	281	285
1200	249	253	256	260	264	267	271	274	278	281	285	288	292
1250	256	260	263	267	271	274	278	282	285	289	292	296	300
1300	262	266	270	274	277	281	285	288	292	296	299	303	307
1350	269	272	276	280	284	288	291	295	299	303	306	310	314
1400	275	279	283	286	290	294	298	302	306	310	313	317	321
1450	281	285	289	293	297	301	305	309	313	317	321	324	328
1500	287	291	295	299	303	307	311	315	319	323	327	331	336
1550	295	299	303	307	311	315	319	323	327	331	335	340	344
1600	301	305	309	313	317	322	326	330	334	338	342	347	351
1650	307	311	315	320	324	328	332	337	341	345	349	354	358
1700	313	318	322	326	330	335	339	343	348	352	356	361	365

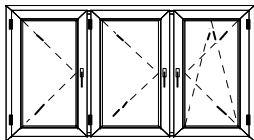

Trojkrídlové okno O-O-OS

Aluplast IDEAL 5000

v/š	2200	2250	2300	2350	2400	2450	2500	2550	2600	2650	2700	2750	2800	2850
700	255	258	260	262	265	268	271	274	276	279	286	289	297	300
750	262	265	268	270	273	276	279	282	285	288	295	298	306	308
800	270	273	276	278	281	284	287	290	293	296	303	306	314	317
850	277	280	283	286	289	293	296	299	302	305	312	315	323	326
900	285	288	291	295	298	301	304	307	310	313	320	324	332	335
950	293	296	299	303	306	309	312	315	318	322	329	332	340	344
1000	301	304	307	311	314	317	320	324	327	330	338	341	349	352
1050	313	317	320	323	327	330	333	337	340	343	351	354	362	366
1100	321	324	328	331	335	338	341	345	348	352	359	363	371	375
1150	329	332	336	339	343	346	350	353	357	360	368	371	380	383
1200	337	340	344	347	351	354	358	362	365	369	376	380	389	392
1250	347	351	355	358	362	366	369	373	377	380	388	392	400	404
1300	355	359	363	366	370	374	378	381	385	389	397	400	409	413
1350	363	367	371	374	378	382	386	390	393	397	405	409	418	422
1400	371	375	379	382	386	390	394	398	402	406	414	418	427	430
1450	379	383	387	390	394	398	402	406	410	414	422	426	435	439
1500	386	391	395	399	403	407	411	415	419	423	431	435	444	448
1550	397	401	405	409	414	418	422	426	430	434	442	446	456	460
1600	405	409	413	417	422	426	430	434	438	443	451	455	464	469
1650	413	417	421	426	430	434	438	443	447	451	459	464	473	477
1700	421	425	429	434	438	442	447	451	455	460	468	472	482	486

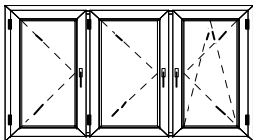

Trojkrídlové okno O-O-OS

Aluplast IDEAL 5000

v/š	2900	2950	3000	3050	3100	3150	3200	3250	3300
700	302	305	308	311	314	316	319	322	325
750	311	314	317	320	323	326	329	331	334
800	320	323	326	329	332	335	338	341	344
850	329	332	335	338	341	344	347	350	353
900	338	341	344	347	350	353	357	360	363
950	347	350	353	356	359	363	366	369	372
1000	356	359	362	365	369	372	375	378	382
1050	369	372	376	379	382	386	389	392	396
1100	378	381	385	388	392	395	399	402	405
1150	387	390	394	397	401	404	408	411	415
1200	396	399	403	406	410	414	417	421	424
1250	408	411	415	419	422	426	430	433	437
1300	417	420	424	428	431	435	439	443	446
1350	425	429	433	437	441	444	448	452	456
1400	434	438	442	446	450	454	457	461	465
1450	443	447	451	455	459	463	467	471	475
1500	452	456	460	464	468	472	476	480	484
1550	464	468	472	476	480	484	488	492	497
1600	473	477	481	485	489	494	498	502	506
1650	482	486	490	494	499	503	507	511	516
1700	490	495	499	503	508	512	516	521	525

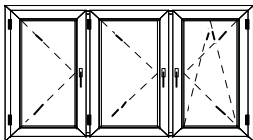

Trojkřídlové okno so štulpom O-O-OS

Aluplast IDEAL 5000

v/š	2200	2250	2300	2350	2400	2450	2500	2550	2600	2650	2700	2750	2800	2850
700	270	272	274	277	280	283	285	288	291	298	301	306	312	315
750	276	279	282	285	288	291	294	297	299	307	310	314	321	323
800	284	287	290	293	296	299	302	305	308	315	318	323	329	332
850	294	297	300	303	306	309	312	315	318	325	328	333	339	342
900	306	309	312	315	318	321	324	328	331	338	341	346	353	356
950	314	317	320	323	326	330	333	336	339	347	350	355	361	364
1000	321	325	328	331	334	338	341	344	348	355	358	364	370	373
1050	333	337	340	343	347	350	353	357	360	368	371	376	383	386
1100	341	345	348	352	355	358	362	365	369	376	380	385	392	395
1150	349	353	356	360	363	367	370	373	377	385	388	394	400	404
1200	357	361	364	368	371	375	378	382	385	393	397	402	409	413
1250	368	371	375	379	382	386	390	393	397	405	409	414	421	425
1300	376	379	383	387	391	394	398	402	405	414	417	423	430	434
1350	383	387	391	395	399	402	406	410	414	422	426	431	439	442
1400	391	395	399	403	407	411	415	418	422	431	435	440	447	451
1450	401	405	409	412	416	420	424	428	432	441	444	450	457	461
1500	408	412	416	420	425	429	433	437	441	449	453	459	466	470
1550	418	422	426	430	435	439	443	447	451	460	464	470	477	481
1600	426	430	434	439	443	447	451	455	459	468	472	478	486	490
1650	434	438	442	447	451	455	459	464	468	477	481	487	494	499
1700	442	446	450	455	459	463	468	472	476	485	489	496	503	507

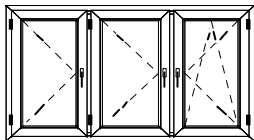

Trojkrídlové okno so štulpom O-O-OS

Aluplast IDEAL 5000

v/š	2900	2950	3000	3050	3100	3150	3200	3250	3300
700	317	320	323	326	329	331	334	337	340
750	326	329	332	335	338	341	343	346	349
800	335	338	341	344	347	350	353	356	359
850	345	348	351	355	358	361	364	367	370
900	359	362	365	368	371	374	377	380	384
950	368	371	374	377	380	384	387	390	393
1000	377	380	383	386	390	393	396	399	403
1050	390	393	396	400	403	406	410	413	416
1100	399	402	405	409	412	416	419	422	426
1150	407	411	414	418	421	425	428	432	435
1200	416	420	423	427	431	434	438	441	445
1250	428	432	436	439	443	446	450	454	457
1300	437	441	445	448	452	456	460	463	467
1350	446	450	454	458	461	465	469	473	476
1400	455	459	463	467	471	474	478	482	486
1450	465	469	473	477	481	485	489	493	497
1500	474	478	482	486	490	494	498	502	506
1550	485	489	493	497	501	506	510	514	518
1600	494	498	502	507	511	515	519	523	527
1650	503	507	511	516	520	524	528	533	537
1700	512	516	520	525	529	533	538	542	546

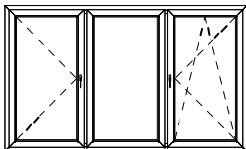

Trojdielné okno O-Fix-OS

Aluplast IDEAL 5000

v/š	1600	1650	1700	1750	1800	1850	1900	1950	2000	2050	2100	2150	2200	2250
700	211	213	215	217	219	222	224	226	228	230	233	236	237	240
750	216	219	221	223	225	227	229	231	233	235	239	241	244	247
800	222	224	226	228	230	232	234	236	238	241	246	249	252	255
850	227	229	231	233	235	237	240	243	246	249	253	256	259	262
900	232	234	236	238	241	244	247	250	253	256	261	264	267	270
950	239	241	243	246	249	252	256	259	262	265	269	272	275	278
1000	244	247	250	253	256	260	263	266	269	273	276	280	283	286
1050	253	257	260	263	267	270	273	277	280	283	287	290	294	297
1100	260	264	267	270	274	277	281	284	287	291	295	298	302	305
1150	267	271	274	277	281	285	288	291	295	298	302	306	309	313
1200	274	278	281	285	288	292	295	299	302	306	310	314	317	321
1250	283	287	291	294	298	301	305	309	312	316	320	324	327	331
1300	290	294	298	301	305	309	312	316	320	324	328	331	335	339
1350	297	301	305	308	312	316	320	324	327	331	335	339	343	347
1400	304	308	312	315	319	323	327	331	335	339	343	347	351	355
1450	311	315	319	323	327	331	334	338	342	346	351	355	359	362
1500	318	322	326	330	334	338	342	346	350	354	358	362	366	370
1550	326	331	335	339	343	347	351	355	359	363	368	372	376	380
1600	333	338	342	346	350	354	358	363	367	371	376	380	384	388
1650	340	345	349	353	357	362	366	370	374	378	383	387	392	396
1700	347	351	356	360	364	369	373	377	382	386	391	395	399	404

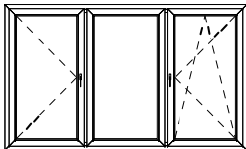

Trojdielné okno O-Fix-OS

Aluplast IDEAL 5000

v/š	2300	2350	2400	2450	2500	2550	2600	2650	2700	2750	2800	2850	2900	2950
700	242	244	247	250	253	256	258	261	265	268	276	278	281	284
750	250	252	255	258	261	264	267	270	273	276	284	287	290	293
800	258	260	263	266	269	272	275	278	282	285	293	296	299	302
850	266	268	271	275	278	281	284	287	291	294	302	305	308	311
900	273	277	280	283	286	289	292	295	299	302	310	313	317	320
950	281	285	288	291	294	297	300	304	308	311	319	322	326	329
1000	289	293	296	299	302	306	309	312	316	320	328	331	334	338
1050	300	304	307	310	314	317	320	324	328	331	340	343	346	350
1100	308	312	315	319	322	325	329	332	336	340	348	352	355	359
1150	316	320	323	327	330	334	337	341	345	349	357	361	364	368
1200	324	328	331	335	338	342	346	349	354	357	366	369	373	376
1250	335	338	342	346	349	353	356	360	365	368	377	381	384	388
1300	343	346	350	354	357	361	365	369	373	377	386	389	393	397
1350	351	354	358	362	366	369	373	377	382	385	394	398	402	406
1400	358	362	366	370	374	378	382	386	390	394	403	407	411	415
1450	366	370	374	378	382	386	390	394	399	403	412	416	420	424
1500	374	378	382	386	390	394	398	402	407	411	421	425	429	433
1550	384	388	392	397	401	405	409	413	418	422	431	435	439	443
1600	392	396	401	405	409	413	417	421	426	431	440	444	448	452
1650	400	404	409	413	417	421	426	430	435	439	449	453	457	461
1700	408	412	417	421	425	430	434	438	444	448	457	462	466	470

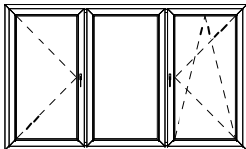

Trojdielné okno O-Fix-OS

Aluplast IDEAL 5000

v/š	3000	3050	3100	3150	3200	3250	3300
700	287	290	292	295	298	301	304
750	296	299	301	304	307	310	313
800	305	308	311	314	317	320	322
850	314	317	320	323	326	329	332
900	323	326	329	332	335	338	341
950	332	335	338	341	345	348	351
1000	341	344	347	351	354	357	360
1050	353	356	360	363	366	370	373
1100	362	365	369	372	376	379	382
1150	371	375	378	381	385	388	392
1200	380	384	387	391	394	398	401
1250	391	395	399	402	406	410	413
1300	401	404	408	412	415	419	423
1350	410	413	417	421	425	428	432
1400	419	422	426	430	434	438	442
1450	428	432	435	439	443	447	451
1500	437	441	445	449	453	457	461
1550	448	452	456	460	464	468	472
1600	457	461	465	469	473	477	482
1650	466	470	474	478	483	487	491
1700	475	479	483	488	492	496	501

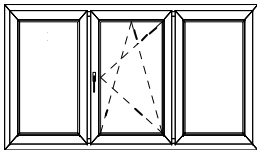

Trojdielne okno Fix-OS-Fix

Aluplast IDEAL 5000

v/š	2200	2250	2300	2350	2400	2450	2500	2550	2600	2650	2700	2750	2800	2850
700	220	222	224	226	229	232	235	238	240	244	249	251	254	257
750	226	229	232	234	237	240	243	246	249	253	257	260	263	266
800	234	237	240	242	245	248	251	254	257	261	266	269	272	275
850	241	244	248	250	254	257	260	263	266	270	274	277	280	283
900	249	252	255	259	262	265	268	271	274	278	283	286	289	292
950	257	260	263	267	270	273	276	279	283	287	291	295	298	301
1000	265	268	271	275	278	281	284	288	291	295	300	303	307	310
1050	274	278	281	284	287	291	294	297	301	305	310	313	317	320
1100	282	285	289	292	296	299	302	306	309	314	319	322	326	329
1150	290	293	297	300	304	307	311	314	318	322	327	331	334	338
1200	298	301	305	308	312	315	319	322	326	330	336	339	343	347
1250	307	311	314	318	322	325	329	333	336	341	346	350	353	357
1300	315	319	322	326	330	334	337	341	345	349	355	359	362	366
1350	323	327	330	334	338	342	345	349	353	358	363	367	371	375
1400	331	334	338	342	346	350	354	358	361	366	372	376	380	383
1450	338	342	346	350	354	358	362	366	370	375	380	384	388	392
1500	346	350	354	358	362	366	370	374	378	383	389	393	397	401
1550	355	359	363	367	371	375	379	384	388	393	399	403	407	411
1600	363	367	371	375	379	384	388	392	396	401	407	411	415	420
1650	370	375	379	383	388	392	396	400	405	410	416	420	424	428
1700	378	383	387	391	396	400	404	409	413	418	424	429	433	437

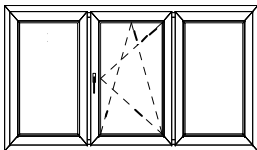

Trojdielne okno Fix-OS-Fix

Aluplast IDEAL 5000

v/š	2900	2950	3000	3050	3100	3150	3200	3250	3300
700	260	263	265	268	271	274	277	279	283
750	269	272	274	277	280	283	286	289	292
800	278	281	284	286	289	292	295	298	302
850	286	289	292	296	299	302	305	308	311
900	295	298	302	305	308	311	314	317	321
950	304	307	311	314	317	320	323	326	330
1000	313	316	320	323	326	329	333	336	340
1050	323	327	330	333	337	340	343	347	351
1100	332	336	339	343	346	349	353	356	360
1150	341	345	348	352	355	359	362	366	370
1200	350	354	357	361	364	368	371	375	379
1250	361	364	368	372	375	379	383	386	390
1300	370	373	377	381	384	388	392	396	400
1350	378	382	386	390	394	397	401	405	409
1400	387	391	395	399	403	407	411	414	419
1450	396	400	404	408	412	416	420	424	428
1500	405	409	413	417	421	425	429	433	438
1550	415	419	423	427	431	435	440	444	448
1600	424	428	432	436	440	445	449	453	458
1650	433	437	441	445	450	454	458	462	467
1700	442	446	450	455	459	463	467	472	477

Balkónové dvere OS

Aluplast IDEAL 5000

v/š	600	650	700	750	800	850	900	950	1000
1800	146	150	155	160	164	169	173	180	185
1850	148	153	158	163	167	172	176	183	188
1900	151	156	160	165	170	175	179	187	191
1950	159	164	168	173	178	183	188	195	200
2000	161	166	171	176	181	186	191	198	203
2050	164	169	174	179	184	189	193	201	206
2100	166	171	176	182	187	192	197	204	209
2150	169	174	179	184	189	194	199	207	212
2200	172	177	182	187	193	198	203	210	216
2250	174	179	185	190	195	201	206	214	219
2300	177	182	187	193	198	203	209	217	222
2350	179	185	190	196	201	206	212	220	225
2400	182	187	193	198	204	209	215	223	228

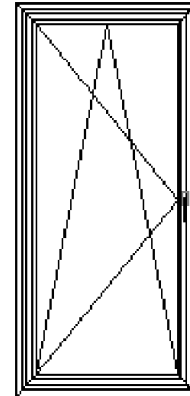

Balkónové dvere O

Aluplast IDEAL 5000

v/š	600	650	700	750	800	850	900	950	1000
1800	136	141	145	150	154	159	163	171	175
1850	139	143	148	152	157	161	166	174	178
1900	141	146	151	155	160	164	169	177	182
1950	147	151	156	161	166	170	175	183	188
2000	149	154	159	164	168	173	178	186	191
2050	152	157	161	166	171	176	181	189	194
2100	154	159	164	169	174	179	184	192	197
2150	157	162	167	172	177	182	187	195	200
2200	159	164	169	175	180	185	190	198	203
2250	162	167	172	177	183	188	193	201	206
2300	164	170	175	180	185	191	196	204	210
2350	167	172	178	183	188	194	199	207	213
2400	169	175	180	186	191	196	202	210	216

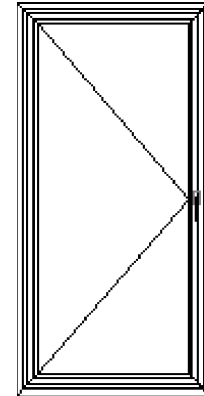

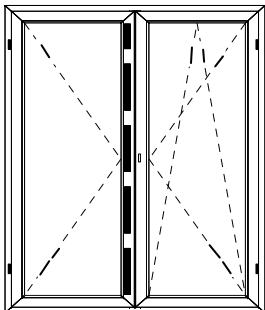

Balkónové dvere so štulpom O-OS

Aluplast IDEAL 5000

v/š	1400	1450	1500	1550	1600	1650	1700	1750	1800	1850	1900	1950	2000	2050	2100
1800	316	320	325	329	334	338	343	347	353	362	367	371	376	380	385
1850	321	326	330	335	339	344	348	353	358	368	373	377	382	387	391
1900	326	331	336	340	345	349	354	359	364	374	379	383	388	393	397
1950	341	345	350	355	359	364	369	373	379	389	394	399	403	408	413
2000	346	351	355	360	365	370	374	379	385	395	400	405	409	414	419
2050	351	356	361	366	370	375	380	385	391	401	406	411	416	420	425
2100	356	361	366	371	376	381	386	391	397	407	412	417	422	427	432
2150	361	366	371	376	381	386	391	396	402	413	418	423	428	433	438
2200	367	372	377	382	387	392	397	402	408	419	424	429	434	439	444
2250	372	377	382	388	393	398	403	408	414	425	430	435	440	445	451
2300	377	382	388	393	398	403	409	414	420	431	436	441	446	452	457
2350	382	388	393	398	404	409	414	420	426	437	442	447	452	458	463
2400	388	393	398	404	409	415	420	425	432	442	448	453	459	464	469

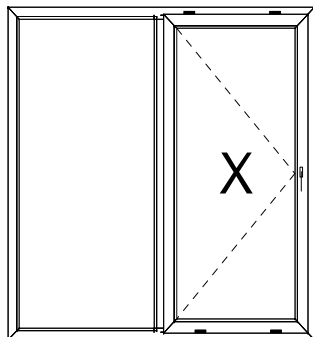

Posuvné dvere Aluplast IDEAL 5000 manuálny posuv

v/š	1800	1850	1900	1950	2000	2050	2100	2150	2200	2250	2300	2350	2400	2450	2500
1800	436	438	441	444	456	459	462	465	467	470	483	485	488	490	493
1850	440	442	445	448	460	463	466	469	472	474	487	490	492	495	497
1900	443	446	449	451	464	467	469	473	475	478	491	494	496	499	502
1950	448	450	453	456	469	472	474	478	480	483	496	499	501	504	507
2000	451	454	457	459	472	475	478	481	484	487	500	503	505	508	511
2050	454	457	460	463	476	479	482	485	488	491	504	506	509	512	515
2100	458	461	464	467	480	483	486	489	492	495	508	511	514	517	519
2150	462	464	467	470	483	486	489	493	496	499	512	515	518	520	523
2200	465	468	471	474	487	490	493	497	500	503	515	518	521	524	527
2250	468	471	474	477	491	494	497	500	503	506	519	522	525	528	531
2300	472	475	478	481	494	497	500	504	507	510	523	526	529	532	535
2350	476	479	482	485	499	502	505	509	512	515	528	531	534	537	540
2400	-	-	486	489	502	505	509	512	515	519	532	535	538	541	544

Poznámka: na posuvné dvere Aluplast IDEAL 5000 manuálny posuv sa nevzťahuje zľava

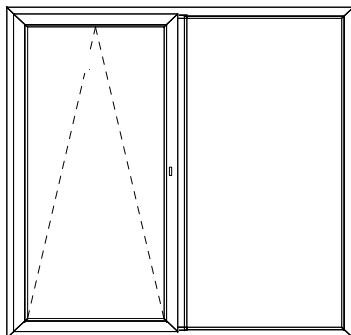

Posuvné dvere Aluplast IDEAL 5000 automatic

v/š	1800	1850	1900	1950	2000	2050	2100	2150	2200	2250	2300	2350	2400	2450	2500
1800	630	632	635	638	646	649	651	654	657	659	672	674	677	680	682
1850	633	636	638	641	650	652	655	658	660	663	676	678	681	683	686
1900	636	639	642	645	653	656	659	661	664	667	679	682	685	688	690
1950	640	643	645	648	657	660	662	665	668	671	683	686	689	692	694
2000	643	646	649	652	660	663	666	669	672	674	687	690	693	695	698
2050	646	649	652	654	663	666	669	672	675	677	690	693	696	699	702
2100	649	652	655	658	667	670	673	676	678	681	694	697	700	703	706
2150	653	655	658	661	670	673	676	679	682	685	698	701	704	707	710
2200	656	659	662	665	674	677	680	683	686	689	702	705	708	711	714
2250	660	663	666	669	678	681	684	687	690	693	706	710	713	716	719
2300	663	666	670	673	682	685	688	691	694	697	710	713	716	720	723
2350	-	-	-	-	685	689	692	695	698	701	714	717	720	723	727
2400	-	-	-	-	689	692	695	698	702	705	718	721	724	727	731

Poznámka: na posuvné dvere Aluplast IDEAL 5000 automatic sa nevzťahuje zľava

Cenová ponuka na plastové okná

OKNO:..... Farba:.....

AKCIA:.....

<i>p</i> <i>.č</i>	<i>Pohľad okna z vnútra</i>	<i>Rozmery</i>		<i>Kusov:</i>	<i>Poznámka</i>
		š			
		v			
		š			
		v			
		š			
		v			

Objednávka na plastové okná

OKNO:..... Farba:.....

AKCIA:.....

<i>p .č</i>	<i>Pohľad okna z vnútra</i>	<i>Rozmery</i>		<i>Kusov:</i>	<i>Poznámka</i>
		š			
		v			
		š			
		v			
		š			
		v			

